

Nama Jurnal : Journal of Advance Research in Fluid Mechanics and Thermal Sciences  
Judul Artikel : Development of the Dethridge Wheel Blade Shape for Hydropower Generation in Irrigation Canals in Indonesia  
Penulis : **Dan Mugisidi**, Irfan Nur Fauzi, Oktarina Heriyani, Yusuf Djeli, Erwin Aidhilhan, Pancatatva Hesti Gunawan.  
Status Penulis : Koresponden  
Volume : Volume 98, No. 2, October (2022)  
Peringkat : Q3



**SEMARAK ILMU**  
PUBLISHING

202103268166 (003316878 - P)

Share your knowledge for a better tomorrow

# Journal of Advanced Research in Fluid Mechanics and Thermal Sciences

ISSN 2289-7879

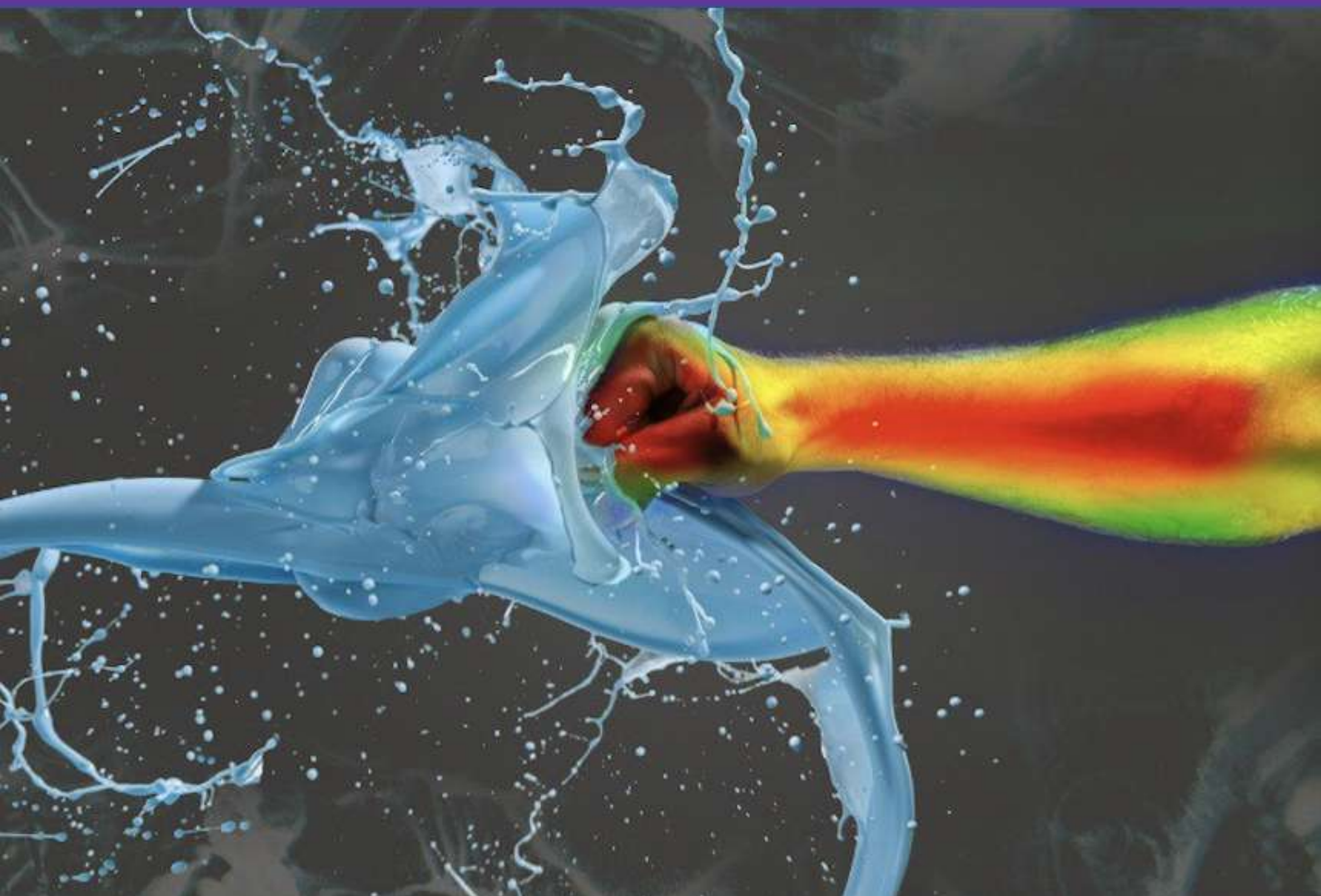

### Properties Q3

<https://www.scimagojr.com/journalsearch.php?q=21100853837&tip=sid&clean=0>

**Journal of Advanced Research in Fluid Mechanics and Thermal Sciences**

<b>COUNTRY</b> Malaysia Universities and research institutions in Malaysia Media Ranking in Malaysia	<b>SUBJECT AREA AND CATEGORY</b> Chemical Engineering Fluid Flow and Transfer Processes	<b>PUBLISHER</b> Penerbit Akademia Baru
<b>H-INDEX</b> <b>21</b>	<b>PUBLICATION TYPE</b> Journals	<b>ISSN</b> 22897879

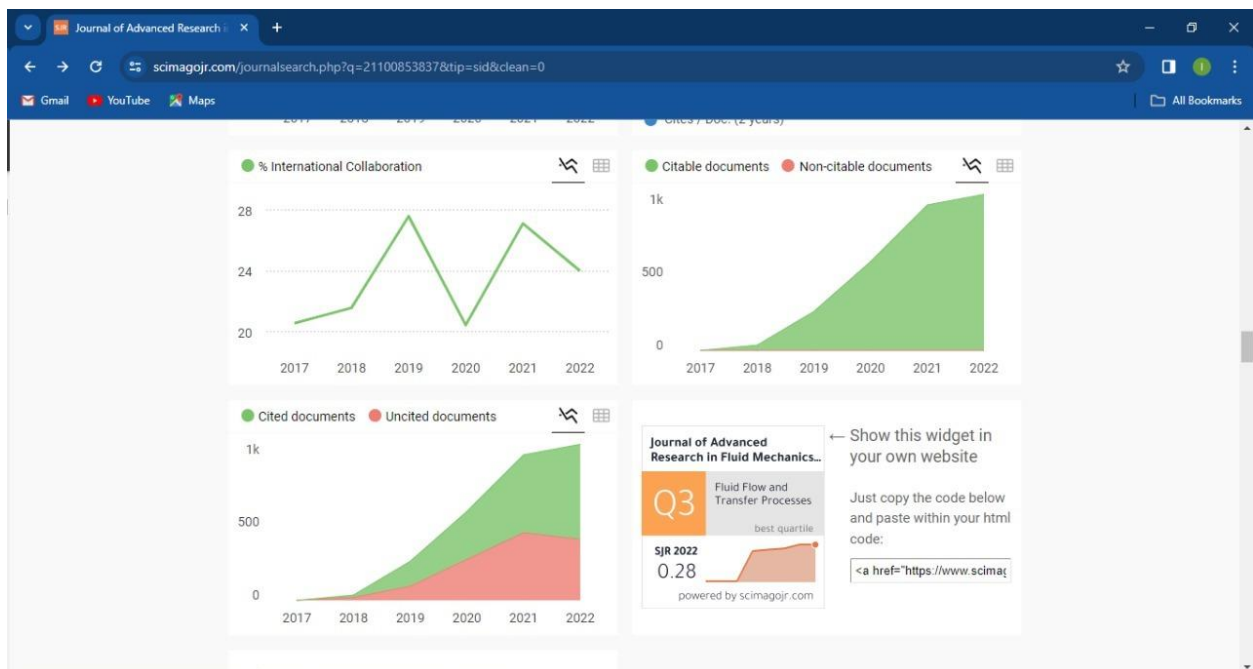

## Link Journal

[https://semarakilmu.com.my/journals/index.php/fluid\\_mechanics\\_thermal\\_sciences/article/view/743](https://semarakilmu.com.my/journals/index.php/fluid_mechanics_thermal_sciences/article/view/743)

The screenshot shows a web browser displaying the article page. The browser's address bar shows the URL: [semarakilmu.com.my/journals/index.php/fluid\\_mechanics\\_thermal\\_sciences/article/view/743](https://semarakilmu.com.my/journals/index.php/fluid_mechanics_thermal_sciences/article/view/743). The page header features the journal title "Journal of Advanced Research in Fluid Mechanics and Thermal Sciences" and navigation links like "Home", "About the Journal", "View Articles", "Guide for Authors", "Submissions", "Search Articles", and "Contact". The article title is "Development of the Dethridge Wheel Blade Shape for Hydropower Generation in Irrigation Canals in Indonesia". The authors listed are Dan Mugisidi, Irfan Nur Fauzi, Oktarina Heriyani, and Yusuf Djell. A photograph of a dethridge wheel experimental rig installation is shown with the caption "Fig. 1. Dethridge wheel experimental rig installation". On the right side, there is a publisher logo for "SEMARAK ILMU PUBLISHING" and a quote: "SHARE YOUR KNOWLEDGE FOR A BETTER TOMORROW".

## Link Editorial Board

[https://semarakilmu.com.my/journals/index.php/fluid\\_mechanics\\_thermal\\_sciences/about/editorialTeam](https://semarakilmu.com.my/journals/index.php/fluid_mechanics_thermal_sciences/about/editorialTeam)

The screenshot shows the editorial board page. The browser's address bar shows the URL: [semarakilmu.com.my/journals/index.php/fluid\\_mechanics\\_thermal\\_sciences/about/editorialTeam](https://semarakilmu.com.my/journals/index.php/fluid_mechanics_thermal_sciences/about/editorialTeam). The page header is identical to the article page. The main content is titled "Editorial Team" and lists the following members:

- Editor-in-Chief:** Dr. Juntakan Taweekun (E-mail), Department of Mechanical and Mechatronics Engineering, Faculty of Engineering, Prince of Songkla University, Songkhla, Thailand.
- Associate Editors:**
  - Dr. Zafar Said (E-mail), College of Engineering, Sustainable & Renewable Energy Engineering Department, University of Sharjah, United Arab Emirates.
  - Dr. Muhammad Noor Afiq Witri Muhammad Yazid (E-mail), Universiti Teknologi Malaysia, Malaysia.
  - Dr. Raoudha Chaabane (E-mail), National Engineering School, Monastir University, Tunisia.
  - Dr. Shervin Sharafatmandjoor (E-mail), Islamic Azzad University, Tehran, Iran.

On the right side, there is a publisher logo for "SEMARAK ILMU PUBLISHING" and a quote: "SHARE YOUR KNOWLEDGE FOR A BETTER TOMORROW". A "Make a Submission" button is visible at the bottom right.

## Daftar Isi

[https://semarakilmu.com.my/journals/index.php/fluid\\_mechanics\\_thermal\\_sciences/issue/view/36](https://semarakilmu.com.my/journals/index.php/fluid_mechanics_thermal_sciences/issue/view/36)

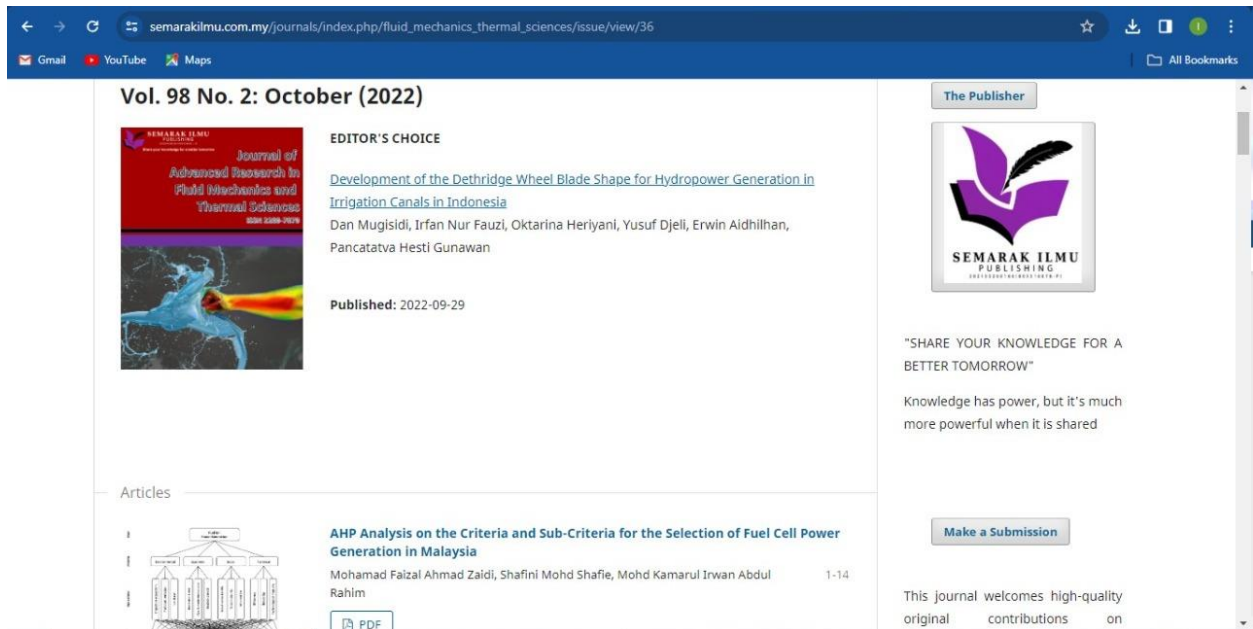

**Vol. 98 No. 2: October (2022)**

**EDITOR'S CHOICE**

[Development of the Dethridge Wheel Blade Shape for Hydropower Generation in Irrigation Canals in Indonesia](#)  
Dan Mugisidi, Irfan Nur Fauzi, Oktarina Heriyani, Yusuf Djell, Erwin Aidhilhan, Pancatavva Hesti Gunawan  
Published: 2022-09-29

**Articles**

[AHP Analysis on the Criteria and Sub-Criteria for the Selection of Fuel Cell Power Generation in Malaysia](#)  
Mohamad Faizal Ahmad Zaidi, Shafini Mohd Shafie, Mohd Kamarul Irwan Abdul Rahim 1-14

**The Publisher**

**SEMARAK ILMU PUBLISHING**

"SHARE YOUR KNOWLEDGE FOR A BETTER TOMORROW"

Knowledge has power, but it's much more powerful when it is shared

[Make a Submission](#)

This journal welcomes high-quality original contributions on

## Link Artikel

[https://semarakilmu.com.my/journals/index.php/fluid\\_mechanics\\_thermal\\_sciences/article/view/743](https://semarakilmu.com.my/journals/index.php/fluid_mechanics_thermal_sciences/article/view/743)

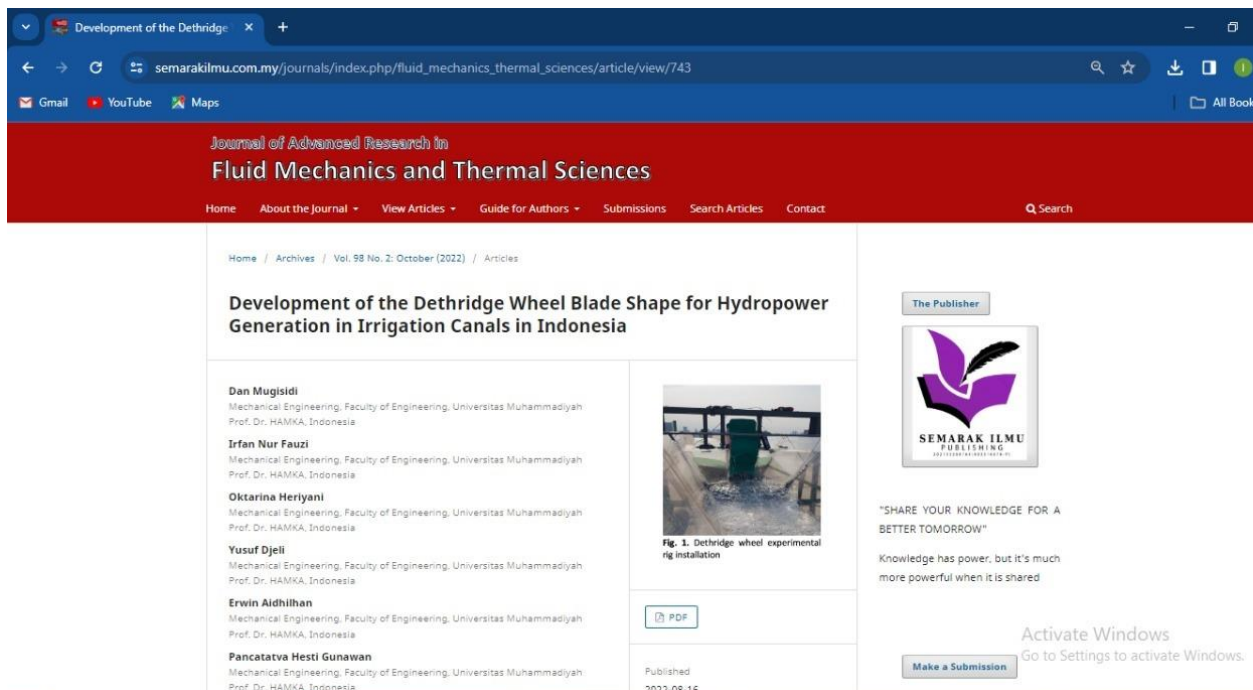

**Journal of Advanced Research in Fluid Mechanics and Thermal Sciences**

Home About the Journal View Articles Guide for Authors Submissions Search Articles Contact

Home / Archives / Vol. 98 No. 2: October (2022) / Articles

**Development of the Dethridge Wheel Blade Shape for Hydropower Generation in Irrigation Canals in Indonesia**

**Dan Mugisidi**  
Mechanical Engineering, Faculty of Engineering, Universitas Muhammadiyah Prof. Dr. HAMKA, Indonesia

**Irfan Nur Fauzi**  
Mechanical Engineering, Faculty of Engineering, Universitas Muhammadiyah Prof. Dr. HAMKA, Indonesia

**Oktarina Heriyani**  
Mechanical Engineering, Faculty of Engineering, Universitas Muhammadiyah Prof. Dr. HAMKA, Indonesia

**Yusuf Djell**  
Mechanical Engineering, Faculty of Engineering, Universitas Muhammadiyah Prof. Dr. HAMKA, Indonesia

**Erwin Aidhilhan**  
Mechanical Engineering, Faculty of Engineering, Universitas Muhammadiyah Prof. Dr. HAMKA, Indonesia

**Pancatavva Hesti Gunawan**  
Mechanical Engineering, Faculty of Engineering, Universitas Muhammadiyah Prof. Dr. HAMKA, Indonesia

**Fig. 1. Dethridge wheel experimental rig installation**

[PDF](#)

Published 2022-08-16

**The Publisher**

**SEMARAK ILMU PUBLISHING**

"SHARE YOUR KNOWLEDGE FOR A BETTER TOMORROW"

Knowledge has power, but it's much more powerful when it is shared

[Make a Submission](#)

Activate Windows  
Go to Settings to activate Windows.



Dan Mugisidi &lt;dan.mugisidi@uhamka.ac.id&gt;

---

**[J. Adv. Res. Fluid Mech. Therm. Sc.] Submission Acknowledgement**

1 message

---

**Dr. Nor Azwadi Che Sidik** <azwadi@akademiabaru.com>

Wed, Jul 27, 2022 at 12:15 PM

To: Dan Mugisidi &lt;dan.mugisidi@uhamka.ac.id&gt;

Dan Mugisidi:

Thank you for submitting the manuscript, "Development of the Dethridge wheel blade shape for hydropower generation in irrigation canals" to Journal of Advanced Research in Fluid Mechanics and Thermal Sciences. With the online journal management system that we are using, you will be able to track its progress through the editorial process by logging in to the journal web site:

Submission URL: [https://semarakilmu.com.my/journals/index.php/fluid\\_mechanics\\_thermal\\_sciences/authorDashboard/submission/743](https://semarakilmu.com.my/journals/index.php/fluid_mechanics_thermal_sciences/authorDashboard/submission/743)

Username: dm1201

If you have any questions, please contact me. Thank you for considering this journal as a venue for your work.

Dr. Nor Azwadi Che Sidik

---

[Journal of Advanced Research in Fluid Mechanics and Thermal Sciences](#)



Dan Mugisidi &lt;dan.mugisidi@uhamka.ac.id&gt;

---

**[J. Adv. Res. Fluid Mech. Therm. Sc.] Editor Decision**

1 message

---

**Nor Azwadi** <azwadi@akademiabaru.com>  
To: Dan Mugisidi <dan.mugisidi@uhamka.ac.id>

Wed, Aug 31, 2022 at 10:09 PM

Dan Mugisidi:

We have reached a decision regarding your submission to Journal of Advanced Research in Fluid Mechanics and Thermal Sciences, "Development of the Dethridge wheel blade shape for hydropower generation in irrigation canals".

**Our decision is: Revisions Required**

Please submit the revised article by 2 Oct 2022

**Editorial Comments:**

Please cite few articles from

<http://www.akademiabaru.com/submit/index.php/progee><http://www.akademiabaru.com/submit/index.php/araset><http://www.akademiabaru.com/submit/index.php/cfdl><http://www.akademiabaru.com/submit/index.php/armne><http://www.akademiabaru.com/submit/index.php/arnht><http://www.akademiabaru.com/submit/index.php/arefmht><http://www.akademiabaru.com/submit/index.php/aram>

Please proofread the paper.

Shallow discussion on past studies

---

[Journal of Advanced Research in Fluid Mechanics and Thermal Sciences](#)



← Back to Submissions

743 / Dan Mugisidi et al. / Development of the Dethridge Wheel Blade Shape for Hydro

Library

Workflow Publication

Submission Review Copyediting Production

Round 1 Round 2

Round 1 Status

One or more reviewers missed their deadline. The editorial team has been notified and will take action to ensure reviews are completed. You do not need to take any action at this time. You will be notified when a decision has been made.

Notifications

<a href="#">[J. Adv. Res. Fluid Mech. Therm. Sc.] Editor De...</a>	2022-08-31 03:09 PM
<a href="#">[J. Adv. Res. Fluid Mech. Therm. Sc.] Editor De...</a>	2022-09-19 11:15 PM
<a href="#">[J. Adv. Res. Fluid Mech. Therm. Sc.] Editor De...</a>	2022-10-04 06:21 AM

Reviewer's Attachments

Search

No Files

Revisions

Search Upload File

▶  3747 743.docx	August 16, 2022	Article Text
------------------	-----------------	--------------



## Review Discussions

[Add discussion](#)

Name	From	Last Reply	Replies	Closed
<i>No Items</i>				



← Back to Submissions

743 / Dan Mugisidi et al. / Development of the Dethridge Wheel Blade Shape for Hydro

Library

Workflow

Publication

Submission

Review

Copyediting

Production

Round 1

Round 2

### Round 2 Status

Submission accepted.

### Notifications

- [\[J. Adv. Res. Fluid Mech. Therm. Sc.\] Editor De...](#) 2022-08-31 03:09 PM
- [\[J. Adv. Res. Fluid Mech. Therm. Sc.\] Editor De...](#) 2022-09-19 11:15 PM
- [\[J. Adv. Res. Fluid Mech. Therm. Sc.\] Editor De...](#) 2022-10-04 06:21 AM

### Reviewer's Attachments

Search

No Files

### Revisions

Search

Upload File

- 4529 Development of the Dethridge wheel blade shape for hydropower generation in irrigation canals\_R2.docx
 September 19, 2022
Article Text

## Review Discussions

[Add discussion](#)

Name	From	Last Reply	Replies	Closed
<i>No Items</i>				



Dan Mugisidi &lt;dan.mugisidi@uhamka.ac.id&gt;

---

**[J. Adv. Res. Fluid Mech. Therm. Sc.] Editor Decision**

1 message

---

**Nor Azwadi** <azwadi@akademiabaru.com>  
To: Dan Mugisidi <dan.mugisidi@uhamka.ac.id>

Tue, Sep 20, 2022 at 6:15 AM

Dan Mugisidi:

We have reached a decision regarding your submission to Journal of Advanced Research in Fluid Mechanics and Thermal Sciences, "Development of the Dethridge wheel blade shape for hydropower generation in irrigation canals".

Our decision is to: Accept Submission

Please make payment of Article Processing Charge of USD400 (International Corresponding Author) or RM1500 (Malaysian Corresponding Author).

The payment can be accomplished through

1) Bank in, Bank transfer or Telegraphic transfer to the following details:

Beneficiary: SEMARAK ILMU PUBLISHING

Bank's Name: CIMB BANK

Account number: 8604899129

Swift code: CIBBMYKLXXX

Full Address: [No 67, Jalan 8/1](#), Section 8, 43650 Bandar Baru Bangi, Selangor, Malaysia

Beneficiary Address: [No 22, Jalan Puteri 5A/3, Bandar Puteri Bangi, 43000 Kajang, Selangor, Malaysia](#)

OR

2) Payment by ConfBay Online Payment Gateway (Credit card/paypal, etc):

Register and upload the accepted paper here

<https://submit.confbay.com/conf/arfmts>

You will receive an invoice and guide for making online payment

Please email the proof of payment to [finance@akademiabaru.com](mailto:finance@akademiabaru.com) before we can begin copyediting of the accepted article.

Thank you

Truly

Editor-in-chief, Journal of Advanced Research in Fluid Mechanics and Thermal Sciences

---

[Journal of Advanced Research in Fluid Mechanics and Thermal Sciences](#)

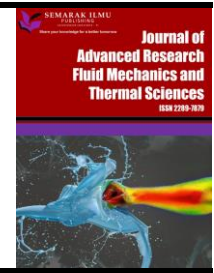

## Development of the Dethridge Wheel Blade Shape for Hydropower Generation in Irrigation Canals in Indonesia

Dan Mugisidi<sup>1,\*</sup>, Irfan Nur Fauzi<sup>1</sup>, Oktarina Heriyani<sup>1</sup>, Yusuf Djeli<sup>1</sup>, Erwin Aidhilhan<sup>1</sup>, Pancatavta Hesti Gunawan<sup>1</sup>

<sup>1</sup> Mechanical Engineering, Faculty of Engineering, Universitas Muhammadiyah Prof. Dr. HAMKA, Indonesia

### ARTICLE INFO

#### Article history:

Received 4 April 2022  
Received in revised form 12 July 2022  
Accepted 23 July 2022  
Available online 16 August 2022

#### Keywords:

Dethridge wheel; waterwheel; wheel blade; hydropower; pico hydro; irrigation

### ABSTRACT

Consumption of electrical energy continues to increase along with population growth. As a result, various sources of electrical energy are utilised to meet these needs, especially in areas that have not been reached by the national electricity network. In countries with hilly geography and irrigation canals, pico hydro energy is often considered an alternative. One of the tools used to convert water flow energy into electrical energy is the Dethridge wheel. The Dethridge wheel is a simple waterwheel that is easy to manufacture and suitable for irrigation canals with very low water head heights. This study aims to increase the performance of the Dethridge wheel by changing the shape of the wheel blades and examine the effect of the variation of water flow rate in the channel. Experimental and numerical methods were used to investigate the potential of the developed wheel. The Dethridge wheel and its development were tested using an artificial irrigation canal with flow rates of 20, 30, 60, 90 and 120 m<sup>3</sup>/h. Furthermore, a three-dimensional numerical model of the Dethridge wheel was simulated using Ansys Fluent 18.2 software. The highest efficiency of the experimental Dethridge wheel, 55.6%, was achieved when the flow rate was 30 m<sup>3</sup>/h. The developed Dethridge wheel efficiency increased to 71.72%. These results are also in agreement with the simulated model.

## 1. Introduction

The global use of electrical energy continues to increase due to general population growth. In 2012, electricity consumption increased by 1.8% from the previous year, and in 2018, it jumped by 4% from 2017 [1]. Until now, the largest source of electrical energy has come from fossil fuels, at 57.1% of electricity generation, followed by nuclear at 18%, and then hydropower at 13.2%, although its utilization is the largest compared to other renewable energy sources [2]. In Indonesia, the target of renewable energy application is 23% by 2025 especially in off-grid areas [3]. In areas with limited access to the national electricity grid, electrical energy generated from micro hydro helps the development of local areas, contributes to improving community welfare and bolsters environmental conservation [4,5]. Furthermore, the availability of power would enhance the growth of industries

\* Corresponding author.

E-mail address: dan.mugisidi@uhamka.ac.id

<https://doi.org/10.37934/arfmts.98.2.146156>

and activities in the service sector and increase its competitiveness [6,7]. However, the utilisation of renewable energy from water energy is not simple, as it is dependent on the weather and geographical conditions [8,9].

If they can be utilised, irrigation canals are a potential source of renewable energy that can provide up to 1.5–2 kW/Ha [10,11]. However, hydropower plants must be able to operate efficiently and not obstruct the environment [12]. An efficient, reliable and cost-effective option is pico hydro, which is produce less than 5 kW of power and can be operated at locations with low water head heights [13,14]. Pico hydro may be more effective to generate power than diesel engines, wind generators and solar cells [15]. The application of pico hydro is suitable for off-grid electricity in Indonesian rural areas even when utilising low heads [16].

For heads less than 5 m, an axial pump can be employed as a generator with a flow rate of 50 to 1000 L/s [17]. Meanwhile, for lower heads, waterwheels are a cost-effective choice as long as the ratio between the radius of the wheel and the submerged radius is at least 0.5 [18]. The Zuppinger mill has an efficiency of up to 75% [19] for a 1 m head, which is reduced to 60% for a 0.5 m head [20]. Even at heads between 0.2 and 1 m, hydrostatic pressure mills can still be used [21]. Meanwhile, Paudel has used the Dethridge mill to generate electrical energy from irrigation flow and has also investigated the optimal wheel size–canal geometry ratio [22,23].

The Dethridge wheel is a waterwheel that is simple and easy to make; it can be made with simple equipment and materials. These mills are suitable for driving generators in irrigation canals with very low heads, although they were initially used as water flow meters. Furthermore, studies have shown that the Dethridge wheel has a weakness due to the shape of the blades, because the force of the water decreases when the blade starts to spin up [24]. However, few improvements have been proposed for the Dethridge wheel blade shape to increase its efficiency. Therefore, this study aims to develop the Dethridge wheel by changing the shape of the blades.

## 2. Methodology

### 2.1 Experimental Setup

This study used an irrigation canal made of transparent plastic with a length of 20 m in accordance with the standard of quaternary irrigation canals in Indonesia [25]. The waterwheel was placed 10 m from the inlet to allow the water flow to become subcritical. To focus the water impulse, the width of the canal was reduced such that the distance between the canal wall and the wheel was only 7 mm on each side, as shown in Figure 1.



**Fig. 1.** Dethridge wheel experimental rig installation

The tools used in this study are listed in Table 1.

**Table 1**  
 Measuring tools used

Measuring Instrument	Type
Rotameter	0–150 [m <sup>3</sup> /h]
Tachometer	KW06-563
Torque meter	Lutron TQ-8800
Flow Velocity meter	Flowatch FL-03

This research compares two systems: the Dethridge wheel (DW) adapted from Paudel and Saenger [22] and a developed Dethridge wheel (dDW) with a different blade shape. The two waterwheels used the same blade material: steel plates with a thickness of 1.8 mm. The two wheels have hub radii of 300 mm and widths of 250 mm. The hub covers are made using wood materials. The dimensions of the DW and dDW can be seen in Figure 2 and Figure 3, respectively.

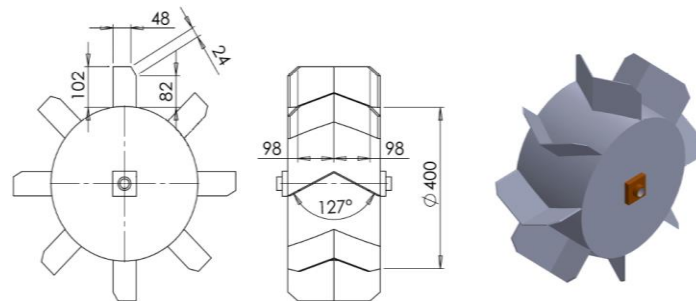

**Fig. 2.** Dethridge wheel geometry

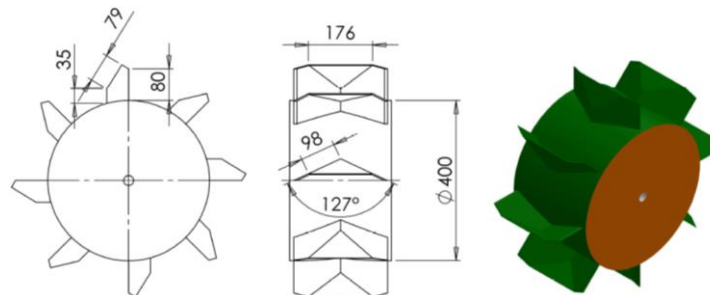

**Fig. 3.** Developed Dethridge wheel geometry

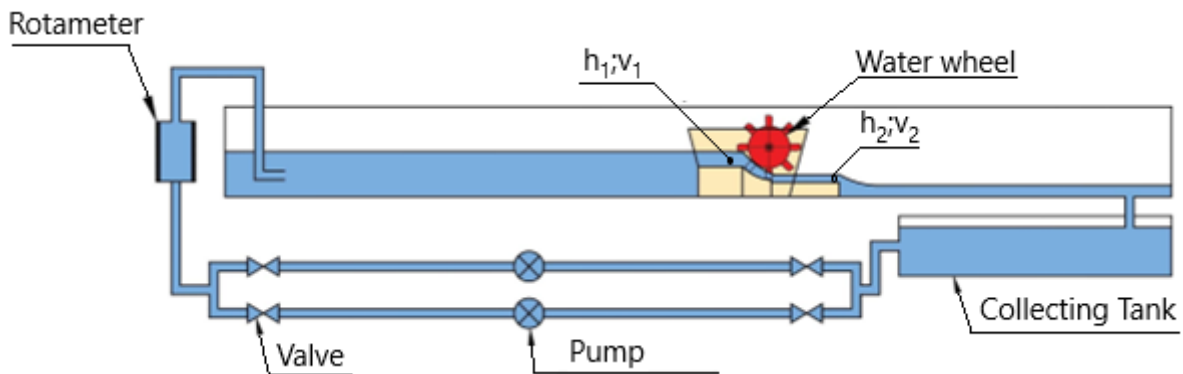

**Fig. 4.** Experimental setup

Two water pumps were used to pump water from the collecting tank to the canal by first passing the water through the rotameter, as shown in Figure 4. The water discharge was regulated by changing the pump rotation. The water that enters the canal flows towards the wheel, and afterward, it enters the collecting tank. Waterpower is obtained by multiplying the pressure due to the head difference with the flow of water (Q). The total head is obtained based on the difference in pressure and speed at the entrance and exit of the wheel, where  $h_1$  and  $v_1$  are the height and velocity of the water entering the wheel, respectively, while  $h_2$  and  $v_2$  are the height and velocity of the water leaving the wheel, respectively [19]

$$H = \left( h_1 + \frac{v_1^2}{2g} \right) - \left( h_2 + \frac{v_2^2}{2g} \right)$$

$$P_i = \rho \times Q \times g \times H$$

The power produced by the wheel is calculated by multiplying the torque (T) and angular velocity ( $\omega$ )

$$P_o = T \times \omega$$

The efficiency of the wheel, which is a comparison of the waterwheel power and the waterpower, is obtained by

$$\eta = \frac{P_o}{P_i} \times 100\%$$

The moving mass of water ( $\dot{m}$ ) causes the water force ( $F_a$ ) to push the blade and create a tangential force of the wheel ( $F_t$ ), which is perpendicular to the shaft of the wheel such that it generates the wheel force ( $F_e$ ) [26,27]

$$\dot{m} = \rho \times A \times v$$

$$F_a = \dot{m} \times (v_2 - v_1)$$

$$F_t = \frac{F_a}{\cos \theta}$$

## 2.2 Computational Fluid Dynamics

Computational fluid dynamics (CFD) is dedicated to determining fluid flow behaviour using computational simulations [28]. The simulation was performed using Ansys Fluent 18.2 software and divided into two geometry models: DW and dDW. Furthermore, the simulation was carried out using 2D following Cleynen *et al.*, [29]. Each model utilised a geometry consisting of a stationary part and a rotating part to control the rotating motion of the turbine and improve the mesh quality.

The mesh used in this simulation had a maximum size of 20 mm globally and a minimum size of 2 mm in high-gradient areas, such as the rotating region, blade and surroundings, as shown in Figure 5 and Figure 6.



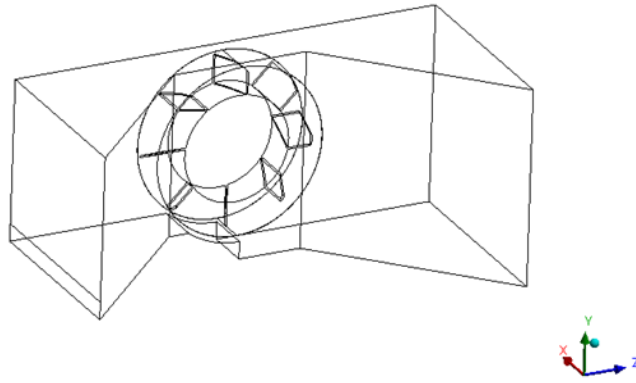

**Fig. 5.** CFD Wheel Geometry

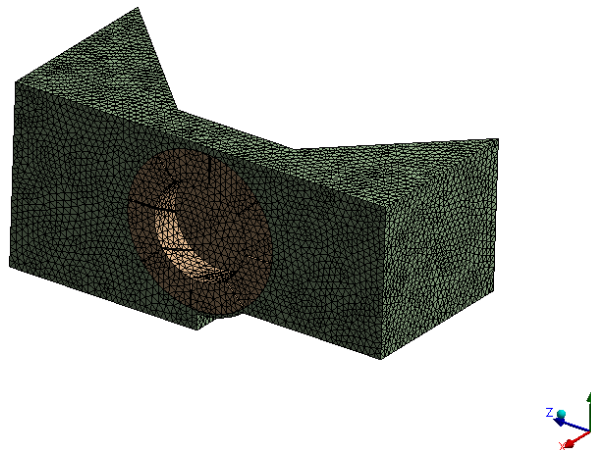

**Fig. 6.** Global Meshing

### 3. Results

#### 3.1 Experimental Data

The waterwheel is given a torque load, which is maintained at 7 kg-cm, while the rotation of the wheel follows the discharge flow. The surface height and water flow velocity before and after the waterwheel change according to the increase in discharge flow, as can be seen in Table 2 and Table 3.

**Table 2**  
Setting of CFD

Gravity	-9.81
Turbulent	k-omega, SST
Mesh Motion	Rotating
Fluid	Air and water

**Table 3**  
Water levels of DW and dDW

Q (m <sup>3</sup> /h)	Water Level DW (m)		Water Level dDW (m)	
	h <sub>1</sub>	h <sub>2</sub>	h <sub>1</sub>	h <sub>2</sub>
20	0.041	0.013	0.040	0.011
30	0.051	0.018	0.056	0.017
60	0.073	0.019	0.068	0.019
90	0.083	0.020	0.074	0.021
120	0.094	0.022	0.088	0.024

The speed of the water before the wheel is different from the water after the wheel. The flow of water before the wheel has a Reynolds number of 2,357 for DW and 2,457 for dDW, which means that the water is in transitional flow and beginning to enter turbulent flow regime. The flow is laminar for  $Re < 500$  in open-channel flow. Also, open channel flow is usually turbulent for  $Re > 2500$  and transitional for  $500 < Re < 2500$  [30]. The flow also appears wavy under visual observation, although the Froude number of the flow before the wheel is in the range of 0.28–0.42 for DW and 0.32–0.44 for dDW. This means that the flow is subcritical and dominated by gravity. Meanwhile, the flow after the wheel is turbulent, with a Reynolds number of 18,800 for both DW and dDW. Additionally, the Froude number after the wheel is 1.53–2.10 for DW and 1.64–2.07 for dDW, which means that the flow has become supercritical. Although the maximum output of the wheel decreases when the Reynolds number increases, the turbine has a blockage ratio of 0.88; thus, almost all of the flow force drives the wheel to rotate [31-33]. Therefore, according to Eq. (2), the waterpower has also increased, as shown in Figure 7.

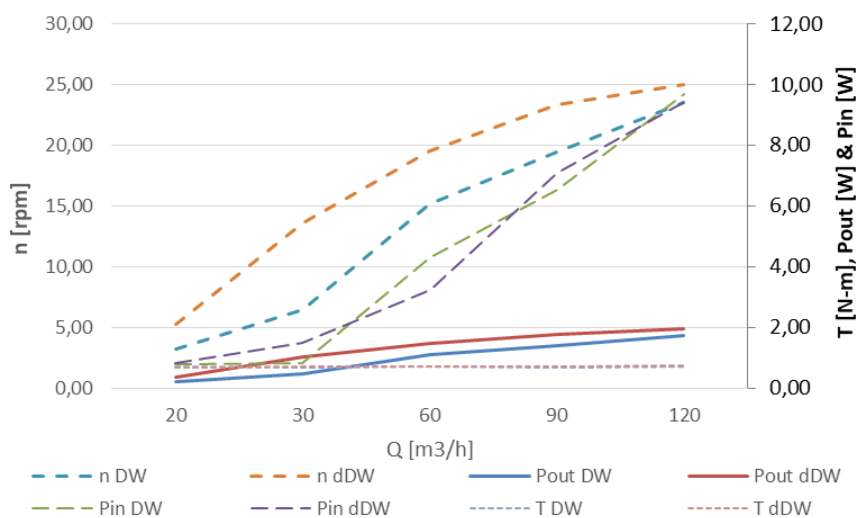

**Fig. 7.** Wheel rotation ( $n$ ), torque ( $T$ ), power of water ( $P_{in}$ ) and power of wheel ( $P_{out}$ ) for DW and dDW

In addition to displaying waterpower, Figure 7 also displays torque, wheel rotation and wheel power. The torque was kept at 0.7 N-m for both waterwheel types. The rotation increased with increasing water discharge. Theoretically, if the water discharge increases, the velocity and mass of the flow also increase, which causes the kinetic energy that moves the blade to increase [34-36]. Hence, the turbine power increases.

It appears that the rotation of the dDW is faster than that of the DW, although the difference becomes smaller with an increase in water discharge. The difference in the efficiency of the two waterwheels also decreased, as shown in Figure 8. The highest efficiency occurred at a discharge of 30 m³/h. At lower water discharge, the mass of water is not strong enough to overcome the waterwheel's inertia [37]. The simulation using CFD produced results that are in line with the experiment, as seen in Table 4.

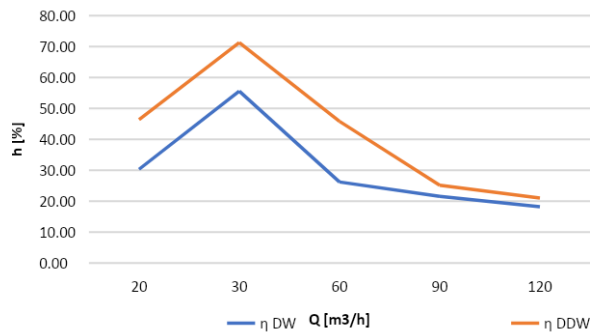

**Fig. 8.** Efficiency of DW and dDW

**Table 4**  
 Velocities of DW and dDW

Q (m <sup>3</sup> /h)	Velocity DW (m/s)		Velocity dDW (m/s)	
	V <sub>1</sub>	V <sub>2</sub>	V <sub>1</sub>	V <sub>2</sub>
w	0.18	0.55	0.20	0.55
	0.25	0.71	0.27	0.70
	0.32	0.80	0.35	0.83
	0.35	0.92	0.40	0.92
	0.41	0.99	0.42	0.97

**Table 5**  
 Torque in CFD simulation [N-m]

Q (m <sup>3</sup> /h)	DW	dDW
20	0.0712	0.1160
30	0.1603	0.2609
60	0.6415	1.0440
90	1.4435	2.3484
120	2.5663	4.1749

The water mass discharge varies between the two waterwheels to the different shapes of the blades, as shown in Figure 9.

Figure 9 demonstrates that the water held by the wheel has piled up, and the water piles up higher for greater flows. This happens for both blade shapes. However, the pile of water in the dDW is higher than in the DW because the water in the DW blades can immediately flow when leaving the shroud at the bottom of the wheel. Meanwhile, in the dDW, the water still pushes the blade at the end of the shroud. This can be explained by looking at the direction of the force acting on the blade, as illustrated in Figure 10.

Figure 10 shows the direction of the velocity when the water enters and leaves the DW and dDW, as presented previously by several studies [38-40]. The dDW has a greater effective velocity than the DW. The shape of the dDW blade enables the water to remain at the end of the shroud for longer. This extends the time and magnitude of the force pushing on the blade, thereby increasing the effective force and power [41,42].

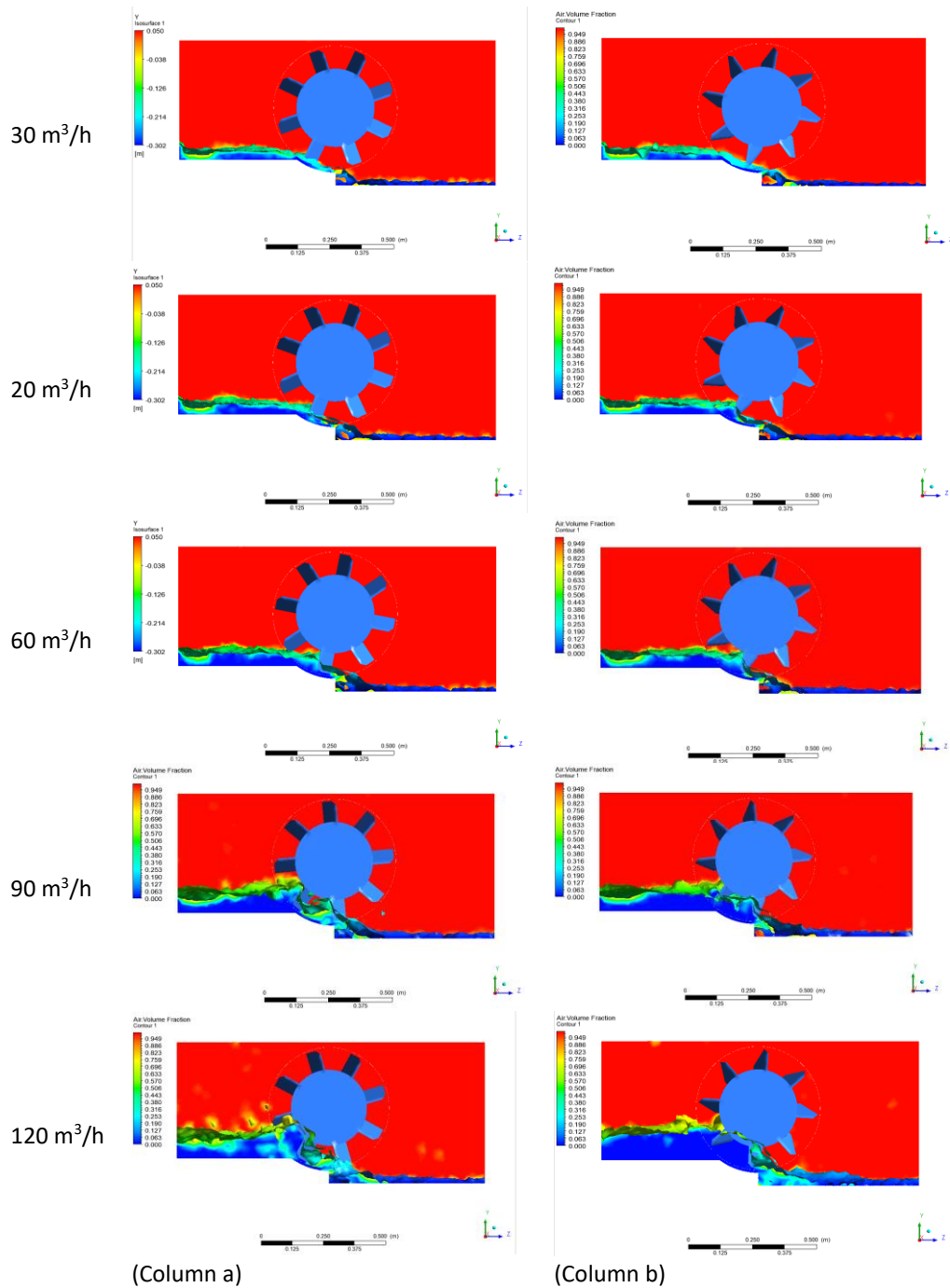

**Fig. 9.** Water mass discharge of (Column a) DW and (Column b) dDW at water discharges of 20, 30, 60, 90 and 120 m<sup>3</sup>/h

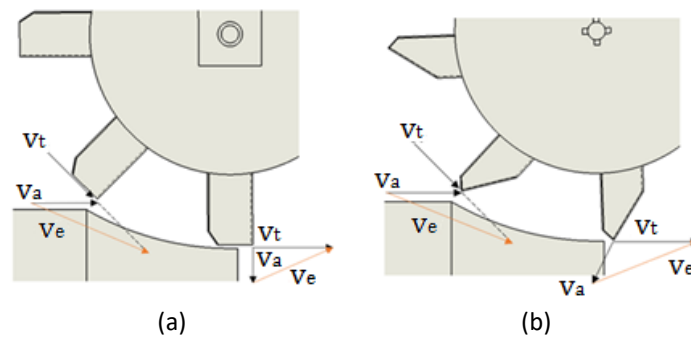

**Fig. 10.** Forces on DW (a) and dDW (b),  $v_t$  is tangential velocity,  $v_a$  is the inlet velocity of water, and  $v_e$  is an effective velocity

#### 4. Conclusions

Although the head height in irrigation canals is usually relatively low, the energy possessed by the flow of water in irrigation canals has not been fully exploited, even though the energy potential is sufficiently large, especially in areas with hilly terrain. Thus, proper tools are needed to convert the flow of water energy into electrical energy. One tool that is simple and easy to manufacture is the Dethridge wheel.

Therefore, several developments pertaining to the Dethridge wheel blade have been conducted to improve its performance. The experimental results show that the shape of the waterwheel blade affects the power and efficiency. The developed Dethridge wheel utilises a blade shape that allows water to push continuously until the blade leaves the canal bed, causing larger forces for a longer duration, which consequently impacts power and efficiency. The highest efficiency of the Dethridge wheel was found to be 55.56%, while that of the developed Dethridge wheel was 71.72%. Thus, the developed Dethridge wheel increases efficiency by 29% at 30 m<sup>3</sup>/h. CFD results are also in agreement with the experiment.

#### Acknowledgement

This research was funded by a grant from Lemlitbang UHAMKA and supported by the Office of UPPI at Universitas Muhammadiyah Prof. Dr. Hamka.

#### References

- [1] British Petroleum. "BP statistical review of world energy June 2013." *London: British Petroleum* (2013).
- [2] International Energy Agency. "Electricity information: Overview (2020 edition)." *IEA* (2020).
- [3] Lubis, Hamzah. "Renewable Energy of Rice Husk for Reducing Fossil Energy in Indonesia." *Journal of Advanced Research in Applied Sciences and Engineering Technology* 11, no. 1 (2018): 17-22.
- [4] Ngowi, Joseph M., Lennart Bångens, and Erik O. Ahlgren. "Benefits and challenges to productive use of off-grid rural electrification: The case of mini-hydropower in Bulongwa-Tanzania." *Energy for Sustainable Development* 53 (2019): 97-103. <https://doi.org/10.1016/j.esd.2019.10.001>
- [5] Harlan, Tyler. "Rural utility to low-carbon industry: Small hydropower and the industrialization of renewable energy in China." *Geoforum* 95 (2018): 59-69. <https://doi.org/10.1016/j.geoforum.2018.06.025>
- [6] Muhammadu, M. M., and J. Usman. "Small Hydropower Development in North-Central of Nigeria: An Assessment." *Journal of Advanced Research in Applied Mechanics* 69, no. 1 (2020) 7-16. <https://doi.org/10.37934/aram.69.1.716>
- [7] Amran, Mohd Effendi, Mohd Nabil Muhtazaruddin, and Habibah@Norehan Haron. "Renewable Energy Optimization Review: Variables towards Competitive Advantage in Green Building Development." *Progress in Energy and Environment* 8 (2019): 1-15.
- [8] Choudhury, Shibabrata, Adikanda Parida, Rajive Mohan Pant, and Saibal Chatterjee. "GIS augmented computational intelligence technique for rural cluster electrification through prioritized site selection of micro-

- hydro power generation system." *Renewable Energy* 142 (2019): 487-496. <https://doi.org/10.1016/j.renene.2019.04.125>
- [9] Lubis, Abubakar. "Energi terbarukan dalam pembangunan berkelanjutan." *Jurnal Teknologi Lingkungan* 8, no. 2 (2007).
- [10] Ueda, Tatsuki, Masahiro Goto, Atsushi Namihira, and Yuichi Hirose. "Perspectives of small-scale hydropower generation using irrigation water in Japan." *Japan Agricultural Research Quarterly: JARQ* 47, no. 2 (2013): 135-140. <https://doi.org/10.6090/jarq.47.135>
- [11] Butera, Ilaria, and Roberto Balestra. "Estimation of the hydropower potential of irrigation networks." *Renewable and Sustainable Energy Reviews* 48 (2015): 140-151. <https://doi.org/10.1016/j.rser.2015.03.046>
- [12] Koç, Cengiz. "A study on operation problems of hydropower plants integrated with irrigation schemes operated in Turkey." *International Journal of Green Energy* 15, no. 2 (2018): 129-135. <https://doi.org/10.1080/15435075.2018.1427591>
- [13] Kadier, Abudukeremu, Mohd Sahaid Kalil, Manoj Pudukudy, Hassimi Abu Hasan, Azah Mohamed, and Aidil Abdul Hamid. "Pico hydropower (PHP) development in Malaysia: Potential, present status, barriers and future perspectives." *Renewable and Sustainable Energy Reviews* 81 (2018): 2796-2805. <https://doi.org/10.1016/j.rser.2017.06.084>
- [14] Williamson, Samuel J., W. David Lubitz, Arthur A. Williams, Julian D. Booker, and Joseph P. Butchers. "Challenges Facing the Implementation of Pico-Hydropower Technologies." *Journal of Sustainability Research* 2, no. 1 (2019). <https://doi.org/10.20900/jsr20200003>
- [15] Balkhair, Khaled S., and Khalil Ur Rahman. "Sustainable and economical small-scale and low-head hydropower generation: A promising alternative potential solution for energy generation at local and regional scale." *Applied Energy* 188 (2017): 378-391. <https://doi.org/10.1016/j.apenergy.2016.12.012>
- [16] Siswantara, Ahmad Indra, Budiarmo Budiarmo, Aji Putro Prakoso, Gun Gun R. Gunadi, Warjito Warjito, and Dendy Adanta. "Assessment of turbulence model for cross-flow pico hydro turbine numerical simulation." *CFD Letters* 10, no. 2 (2018): 38-48.
- [17] Bozorgi, A., E. Javidpour, A. Riasi, and A. Nourbakhsh. "Numerical and experimental study of using axial pump as turbine in pico hydropower plants." *Renewable Energy* 53 (2013): 258-264. <https://doi.org/10.1016/j.renene.2012.11.016>
- [18] Tevata, Anurat, and Chainarong Inprasit. "The effect of paddle number and immersed radius ratio on water wheel performance." *Energy Procedia* 9 (2011): 359-365. <https://doi.org/10.1016/j.egypro.2011.09.039>
- [19] Paudel, Shakun, Martin Weber, Dirk Geyer, and Nicole Saenger. "Zuppinger water wheel for very low-head hydropower application." In *10th International Conference on Sustainable Energy and Environment Protection: Marine and Hydro Power*, pp. 25-34. University of Maribor Press, 2017. <https://doi.org/10.18690/978-961-286-055-4.3>
- [20] Quaranta, Emanuele, and Gerald Müller. "Optimization of undershot water wheels in very low and variable flow rate applications." *Journal of Hydraulic Research* 58, no. 5 (2020): 845-849. <https://doi.org/10.1080/00221686.2019.1671508>
- [21] Senior, James, Nicole Saenger, and Gerald Müller. "New hydropower converters for very low-head differences." *Journal of Hydraulic Research* 48, no. 6 (2010): 703-714. <https://doi.org/10.1080/00221686.2010.529301>
- [22] Paudel, Shakun, and Nicole Saenger. "Dethridge wheel for pico-scale hydropower generation: An experimental and numerical study." In *IOP Conference Series: Earth and Environmental Science*, vol. 49, no. 10, p. 102007. IOP Publishing, 2016. <https://doi.org/10.1088/1755-1315/49/10/102007>
- [23] Paudel, Shakun, and Nicole Saenger. "Effect of channel geometry on the performance of the Dethridge water wheel." *Renewable Energy* 115 (2018): 175-182. <https://doi.org/10.1016/j.renene.2017.08.043>
- [24] Mugisidi, Dan, Oktarina Heriyani, Rizal Andi Luhung, and Moh Ramdani Dwi Andrian. "Utilization of the dethridge wheel as a low head power generator and loss analysis." In *MATEC Web of Conferences*, vol. 204, p. 04003. EDP Sciences, 2018. <https://doi.org/10.1051/mateconf/201820404003>
- [25] Effendy, Effendy. "Disain Saluran Irigasi." *Pilar: Jurnal Teknik Sipil Politeknik Negeri Sriwijaya* 7, no. 2 (2012).
- [26] Boli, Rahmat, Abdul Makhud, and Mahmuddin Tahir. "Analisis Daya Output dan Efisiensi Kincir Air Sudu Miring yang Bekerja pada Saluran Horizontal." *Gorontalo Journal of Infrastructure and Science Engineering* 1, no. 2 (2018): 1-7. <https://doi.org/10.32662/gojise.v1i2.423>
- [27] Denny, Mark. "The efficiency of overshot and undershot waterwheels." *European Journal of Physics* 25, no. 2 (2003): 193. <https://doi.org/10.1088/0143-0807/25/2/006>
- [28] Tu, Jiyuan, Guan Heng Yeoh, and Chaoqun Liu. *Computational fluid dynamics: a practical approach*. Butterworth-Heinemann, 2018.

- [29] Cleynen, Olivier, Emeel Kerikous, Stefan Hoerner, and Dominique Thévenin. "Characterization of the performance of a free-stream water wheel using computational fluid dynamics." *Energy* 165 (2018): 1392-1400. <https://doi.org/10.1016/j.energy.2018.10.003>
- [30] Çengel, Yunus A., and John M. Cimbala. *Fluid Mechanics Fundamentals and Applications (3rd Edition in SI Units)*. McGraw Hill, 2013.
- [31] Vidali, Cristina, Stefano Fontan, Emanuele Quaranta, Paolo Cavagnero, and Roberto Revelli. "Experimental and dimensional analysis of a breastshot water wheel." *Journal of Hydraulic Research* 54, no. 4 (2016): 473-479. <https://doi.org/10.1080/00221686.2016.1147499>
- [32] Mugisidi, Dan, Oktarina Heriyani, Rizal Andi Luhung, and Moh Ramdani Dwi Andrian. "Utilization of the dethridge wheel as a low head power generator and loss analysis." In *MATEC Web of Conferences*, vol. 204, p. 04003. EDP Sciences, 2018. <https://doi.org/10.1051/mateconf/201820404003>
- [33] Quaranta, Emanuele. "Stream water wheels as renewable energy supply in flowing water: Theoretical considerations, performance assessment and design recommendations." *Energy for Sustainable Development* 45 (2018): 96-109. <https://doi.org/10.1016/j.esd.2018.05.002>
- [34] Muliawan, Arief, and Ahmad Yani. "Analisis daya dan efisiensi turbin air kinetis akibat perubahan putaran runner." *Sainstek: Jurnal Sains dan Teknologi* 8, no. 1 (2017): 1-9. <https://doi.org/10.31958/js.v8i1.434>
- [35] Yani, Ahmad, Mihdar Mihdar, and Rudi Erianto. "Pengaruh Variasi Bentuk Sudu Terhadap Kinerja Turbin Air Kinetik (Sebagai Alternatif Pembangkit Listrik Daerah Pedesaan)." *Turbo: Jurnal Program Studi Teknik Mesin* 5, no. 1 (2017). <https://doi.org/10.24127/trb.v5i1.113>
- [36] Bahaj, A. S., A. F. Molland, J. R. Chaplin, and W. M. J. Batten. "Power and thrust measurements of marine current turbines under various hydrodynamic flow conditions in a cavitation tunnel and a towing tank." *Renewable Energy* 32, no. 3 (2007): 407-426. <https://doi.org/10.1016/j.renene.2006.01.012>
- [37] Prabowo, Boy Ilham, and Priyo Heru Adiwibowo. "Eksperimental Kinerja Turbin Reaksi Aliran Vortex Tipe Sudu Berpenampang L Dengan Variasi Panjang Sisi Lurus Pada Ujung Sudu." *Jurnal Teknik Mesin* 6, no. 1 (2018): 115-123.
- [38] Müller, G., and Christian Wolter. "The breastshot waterwheel: design and model tests." In *Proceedings of the Institution of Civil Engineers-Engineering Sustainability*, vol. 157, no. 4, pp. 203-211. Thomas Telford Ltd, 2004. <https://doi.org/10.1680/ensu.2004.157.4.203>
- [39] Zaman, Ayesha, and Taslima Khan. "Design of a water wheel for a low head micro hydropower system." *Journal Basic Science and Technology* 1, no. 3 (2012): 1-6.
- [40] Nguyen, Manh Hung, Haechang Jeong, and Changjo Yang. "A study on flow fields and performance of water wheel turbine using experimental and numerical analyses." *Science China Technological Sciences* 61, no. 3 (2018): 464-474. <https://doi.org/10.1007/s11431-017-9146-9>
- [41] Anam, Asroful, Rudy Soenoko, and Denny Widhiyanuriyawan. "Pengaruh variasi sudut input sudu mangkok terhadap kinerja turbin kinetik." *Jurnal Rekayasa Mesin* 4, no. 3 (2014): 199-203.
- [42] Adanta, Dendy, Satrio Adi Arifianto, and Sanjaya BS Nasution. "Effect of blades number on undershot waterwheel performance with variable inlet velocity." In *2018 4th International Conference on Science and Technology (ICST)*, pp. 1-6. IEEE, 2018.

# Dan Mugisidi - Development of the Dethridge Wheel Blade Shape for Hydropower Generation in Irrigation Canals in Indonesia

*by Dan Mugisidi Uploaded By Lutfan Zulwaqar*

---

**Submission date:** 21-Oct-2022 01:06PM (UTC+0700)

**Submission ID:** 1931318582

**File name:** l\_blade\_shape\_for\_hydropower\_generation\_in\_irrigation\_canals.pdf (818.97K)

**Word count:** 4178

**Character count:** 21669



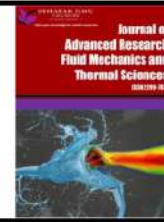

## Development of the Dethridge Wheel Blade Shape for Hydropower Generation in Irrigation Canals in Indonesia

Dan Mugisidi<sup>1,\*</sup>, Irfan Nur Fauzi<sup>1</sup>, Oktarina Heriyani<sup>1</sup>, Yusuf Djeli<sup>1</sup>, Erwin Aidhilhan<sup>1</sup>, Pancatavta Hesti Gunawan<sup>1</sup>

<sup>1</sup> Mechanical Engineering, Faculty of Engineering, Universitas Muhammadiyah Prof. Dr. HAMKA, Indonesia

### ARTICLE INFO

#### Article history:

Received 4 April 2022  
Received in revised form 12 July 2022  
Accepted 23 July 2022  
Available online 16 August 2022

#### Keywords:

Dethridge wheel; waterwheel; wheel blade; hydropower; pico hydro; irrigation

### ABSTRACT

Consumption of electrical energy continues to increase along with population growth. As a result, various sources of electrical energy are utilised to meet these needs, especially in areas that have not been reached by the national electricity network. In countries with hilly geography, irrigation canals, pico hydro energy is often considered an alternative. One of the tools used to convert water flow energy into electrical energy is the Dethridge wheel. The Dethridge wheel is a simple waterwheel that is easy to manufacture and suitable for irrigation canals with very low water head heights. This study aims to increase the performance of the Dethridge wheel by changing the shape of the wheel blades and examine the effect of the variation of water flow rate in the channel. Experimental and numerical methods were used to investigate the potential of the developed wheel. The Dethridge wheel and its development were tested using artificial irrigation canal with flow rates of 20, 30, 60, 90 and 120 m<sup>3</sup>/h. Furthermore, a three-dimensional numerical model of the Dethridge wheel was simulated using Ansys Fluent 18.2 software. The highest efficiency of the experimental Dethridge wheel, 55.6%, was achieved when the flow rate was 30 m<sup>3</sup>/h. The developed Dethridge wheel efficiency increased to 71.72%. These results are also in agreement with the simulated model.

## 1. Introduction

The global use of electrical energy continues to increase due to general population growth. In 2012, electricity consumption increased by 1.8% from the previous year, and in 2018, it jumped by 4% from 2017 [1]. Until now, the largest source of electrical energy has come from fossil fuels, at 57.1% of electricity generation, followed by nuclear at 18%, and then hydropower at 13.2% though its utilization is the largest compared to other renewable energy sources [2]. In Indonesia, the target of renewable energy application is 23% by 2025 especially in off-grid areas [3]. In areas with limited access to the national electricity grid, electrical energy generated from micro hydro helps the development of local areas, contributes to improving community welfare and bolsters environmental conservation [4,5]. Furthermore, the availability of power would enhance the growth of industries

<sup>5</sup> \* Corresponding author.

E-mail address: dan.mugisidi@uhamka.ac.id

<https://doi.org/10.37934/arfmts.98.2.146156>

and activities in the service sector and increase its competitiveness [6,7]. However, the utilisation of renewable energy from water energy is not simple, as it is dependent on the weather and geographical conditions [8,9].

If they can be utilised, irrigation canals are a potential source of renewable energy that can provide up to 1.5–2 kW/Ha [10,11]. However, hydropower plants must be able to operate efficiently and not obstruct the environment [12]. An efficient, reliable and cost-effective option is pico hydro, which is produce less than 5 kW of power and can be operated at locations with low water head heights [13,14]. Pico hydro may be more effective to generate power than diesel engines, wind generators and solar cells [15]. The application of pico hydro is suitable for off-grid electricity in Indonesian rural areas even when utilising low heads [16].

For heads less than 5 m, an axial pump can be employed as a generator with a flow rate of 50 to 1000  $\text{m}^3/\text{s}$  [17]. Meanwhile, for lower heads, waterwheels are a cost-effective choice as long as the ratio between the radius of the wheel and the submerged radius is at least 0.5 [18]. The Zuppinger mill has an efficiency of up to 75% [19] for a 1 m head, which is reduced to 60% for a 0.5 m head [20]. Even at heads between 0.2 and 1 m, hydrostatic pressure mills can still be used [21]. Meanwhile, Paudel has used the Dethridge mill to generate electrical energy from irrigation flow and has also investigated the optimal wheel size–canal geometry ratio [22,23].

The Dethridge wheel is a waterwheel that is simple and easy to make; it can be made with simple equipment and materials. These mills are suitable for driving generators in irrigation canals with very low heads, although they were initially used as water flow meters. Furthermore, studies have shown that the Dethridge wheel has a weakness due to the shape of the blades, because the force of the water decreases when the blade starts to spin up [24]. However, few improvements have been proposed for the Dethridge wheel blade shape to increase its efficiency. Therefore, this study aims to develop the Dethridge wheel by changing the shape of the blades.

## 2. Methodology

### 2.1 Experimental Setup

This study used an irrigation canal made of transparent plastic with a length of 20 m in accordance with the standard of quaternary irrigation canals in Indonesia [25]. The waterwheel was placed 10 m from the inlet to allow the water flow to become subcritical. To focus the water impulse, the width of the canal was reduced such that the distance between the canal wall and the wheel was only 7 mm on each side, as shown in Figure 1.



Fig. 1. Dethridge wheel experimental rig installation

The tools used in this study are listed in Table 1.

**Table 1**

Measuring tools used

Measuring Instrument	Type
Rotameter	0–150 [m <sup>3</sup> /h]
Tachometer	KW06-563
Torque meter	Lutron TQ-8800
Flow Velocity meter	Flowatch FL-03

This research compares two systems: the Dethridge wheel (DW) adapted from Paudel and Saenger [22] and a developed Dethridge wheel (dDW) with a different blade shape. The two waterwheels used the same blade material: steel plates with a thickness of 1.8 mm. The two wheels have hub radii of 300 mm and width of 250 mm. The hub covers are made using wood materials. The dimensions of the DW and dDW can be seen in Figure 2 and Figure 3, respectively.

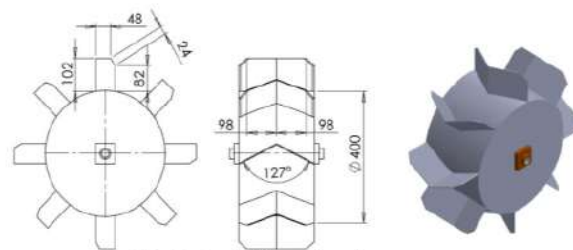

Fig. 2. Dethridge wheel geometry

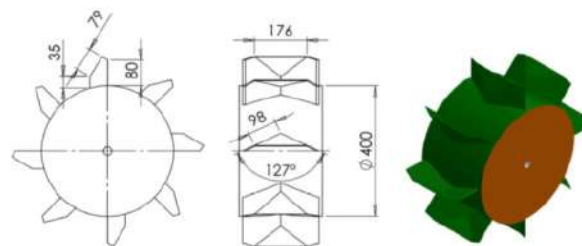

Fig. 3. Developed Dethridge wheel geometry

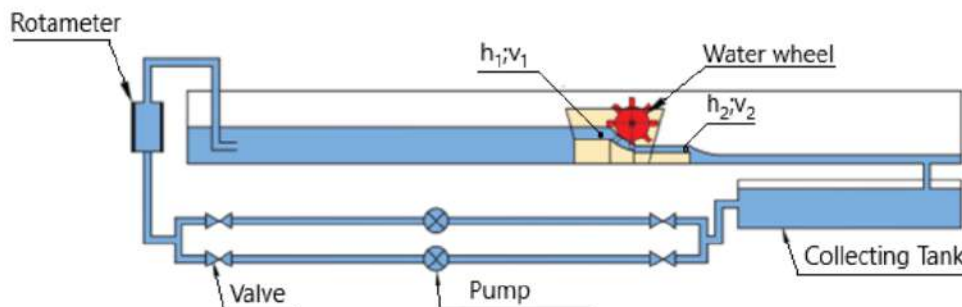

Fig. 4. Experimental setup

Two water pumps were used to pump water from the collecting tank to the canal by first passing the water through the rotameter, as shown in Figure 4. The water discharge was regulated by changing the pump rotation. The water that enters the canal flows towards the wheel, and afterward, it enters the collecting tank. Waterpower is obtained by multiplying the pressure due to the head difference with the flow of water (Q). The total head is obtained based on the difference in pressure and speed at the entrance and exit of the wheel, where  $h_1$  and  $v_1$  are the height and velocity of the water entering the wheel, respectively, while  $h_2$  and  $v_2$  are the height and velocity of the water leaving the wheel, respectively [19]

$$H = \left( h_1 + \frac{v_1^2}{2g} \right) - \left( h_2 + \frac{v_2^2}{2g} \right)$$

$$P_i = \rho \times Q \times g \times H$$

The power produced by the wheel is calculated by multiplying the torque (T) and angular velocity ( $\omega$ )

$$P_o = T \times \omega$$

The efficiency of the wheel, which is a comparison of the waterwheel power and the waterpower, is obtained by

$$\eta = \frac{P_o}{P_i} \times 100\%$$

The moving mass of water ( $\dot{m}$ ) causes the water force ( $F_a$ ) to push the blade and create a tangential force of the wheel ( $F_t$ ), which is perpendicular to the shaft of the wheel such that it generates the wheel force ( $F_e$ ) [26,27]

$$\dot{m} = \rho \times A \times v$$

$$F_a = \dot{m} \times (v_2 - v_1)$$

$$F_t = \frac{F_a}{\cos \theta}$$

9

## 2.2 Computational Fluid Dynamics

Computational fluid dynamics (CFD) is dedicated to determining fluid flow behaviour using computational simulations [28]. The simulation was performed using Ansys Fluent 18.2 software and divided into two geometry models: DW and dDW. Furthermore, the simulation was carried out using 2D following Cleynen *et al.*, [29]. Each model utilised a geometry consisting of a stationary part and a rotating part to control the rotating motion of the turbine and improve the mesh quality.

The mesh used in this simulation had a maximum size of 20 mm globally and a minimum size of 2 mm in high-gradient areas, such as the rotating region, blade and surroundings, as shown in Figure 5 and Figure 6.

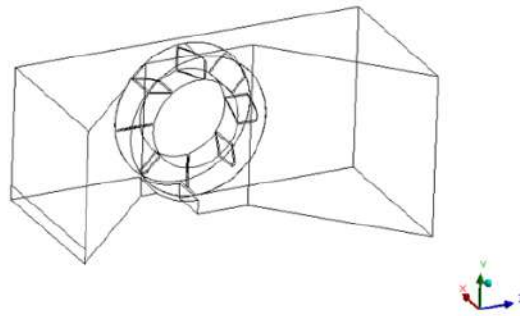

Fig. 5. CFD Wheel Geometry



Fig. 6. Global Meshing

### 3. Results

#### 3.1 Experimental Data

The waterwheel is given a torque load, which is maintained at 7 kg-cm, while the rotation of the wheel follows the discharge flow. The surface height and water flow velocity before and after the waterwheel change according to the increase in discharge flow, as can be seen in Table 2 and Table 3.

**Table 2**  
Setting of CFD

Gravity	-9.81
Turbulent	k-omega, SST
Mesh Motion	Rotating
Fluid	Air and water

**Table 3**  
Water levels of DW and dDW

Q (m <sup>3</sup> /h)	Water Level DW (m)		Water Level dDW (m)	
	h <sub>1</sub>	h <sub>2</sub>	h <sub>1</sub>	h <sub>2</sub>
20	0.041	0.013	0.040	0.011
30	0.051	0.018	0.056	0.017
60	0.073	0.019	0.068	0.019
90	0.083	0.020	0.074	0.021
120	0.094	0.022	0.088	0.024

The speed of the water before the wheel is different from the water after the wheel. The flow of water before the wheel has a Reynolds number of 2,357 for DW and 2,457 for dDW, which means that the water is in transitional flow and beginning to enter turbulent flow regime. The flow is laminar for  $Re < 500$  in open-channel flow. Also, open channel flow is usually turbulent for  $Re > 2500$  and transitional for  $500 < Re < 2500$  [30]. The flow also appears wavy under visual observation, although the Froude number of the flow before the wheel is in the range of 0.28–0.42 for DW and 0.32–0.44 for dDW. This means that the flow is subcritical and dominated by gravity. Meanwhile, the flow after the wheel is turbulent, with a Reynolds number of 18,800 for both DW and dDW. Additionally, the Froude number after the wheel is 1.53–2.10 for DW and 1.64–2.07 for dDW, which means that the flow has become supercritical. Although the maximum output of the wheel decreases when the Reynolds number increases, the turbine has a blockage ratio of 0.88; thus, almost all of the flow force drives the wheel to rotate [31-33]. Therefore, according to Eq. (2), the waterpower has also increased, as shown in Figure 7.

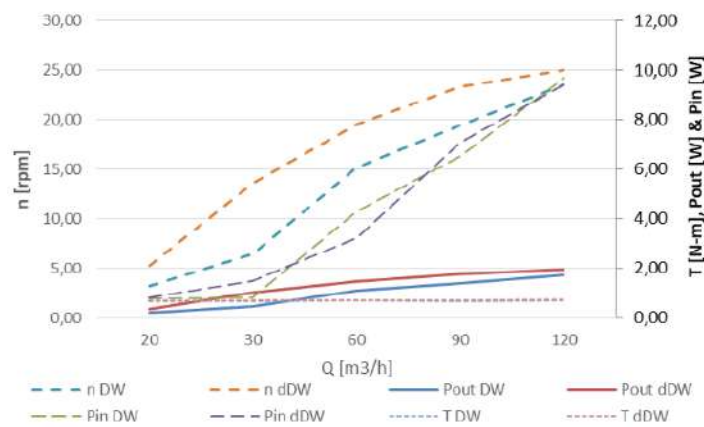

**Fig. 7.** Wheel rotation ( $n$ ), torque ( $T$ ), power of water ( $P_{in}$ ) and power of wheel ( $P_{out}$ ) for DW and dDW

In addition to displaying waterpower, Figure 7 also displays torque, wheel rotation and wheel power. The torque was kept at 0.7 N-m for both waterwheel types. The rotation increased with increasing water discharge. Theoretically, if the water discharge increases, the velocity and mass of the flow also increase, which causes the kinetic energy that moves the blade to increase [34-36]. Hence, the turbine power increases.

It appears that the rotation of the dDW is faster than that of the DW, although the difference becomes smaller with an increase in water discharge. The difference in the efficiency of the two waterwheels also decreased, as shown in Figure 8. The highest efficiency occurred at a discharge of 30 m³/h. At lower water discharge, the mass of water is not strong enough to overcome the waterwheel's inertia [37]. The simulation using CFD produced results that are in line with the experiment, as seen in Table 4.

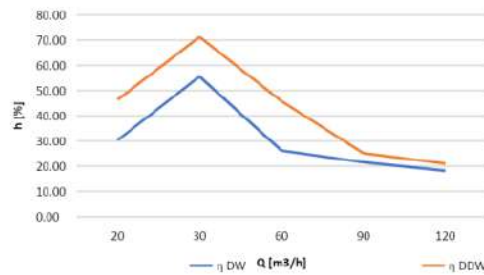

Fig. 8. Efficiency of DW and dDW

**Table 4**  
 Velocities of DW and dDW

Q (m³/h)	Velocity DW (m/s)		Velocity dDW (m/s)	
	V <sub>1</sub>	V <sub>2</sub>	V <sub>1</sub>	V <sub>2</sub>
w	0.18	0.55	0.20	0.55
	0.25	0.71	0.27	0.70
	0.32	0.80	0.35	0.83
	0.35	0.92	0.40	0.92
	0.41	0.99	0.42	0.97

**Table 5**  
 Torque in CFD simulation [N-m]

Q (m³/h)	DW	dDW
20	0.0712	0.1160
30	0.1603	0.2609
60	0.6415	1.0440
90	1.4435	2.3484
120	2.5663	4.1749

The water mass discharge varies between the two waterwheels to the different shapes of the blades, as shown in Figure 9.

Figure 9 demonstrates that the water held by the wheel has piled up, and the water piles up higher for greater flows. This happens for both blade shapes. However, the pile of water in the dDW is higher than in the DW because the water in the DW blades can immediately flow when leaving the shroud at the bottom of the wheel. Meanwhile, in the dDW, the water still pushes the blade at the end of the shroud. This can be explained by looking at the direction of the force acting on the blade, as illustrated in Figure 10.

Figure 10 shows the direction of the velocity when the water enters and leaves the DW and dDW, as presented previously by several studies [38-40]. The dDW has a greater effective velocity than the DW. The shape of the dDW blade enables the water to remain at the end of the shroud for longer. This extends the time and magnitude of the force pushing on the blade, thereby increasing the effective force and power [41,42].

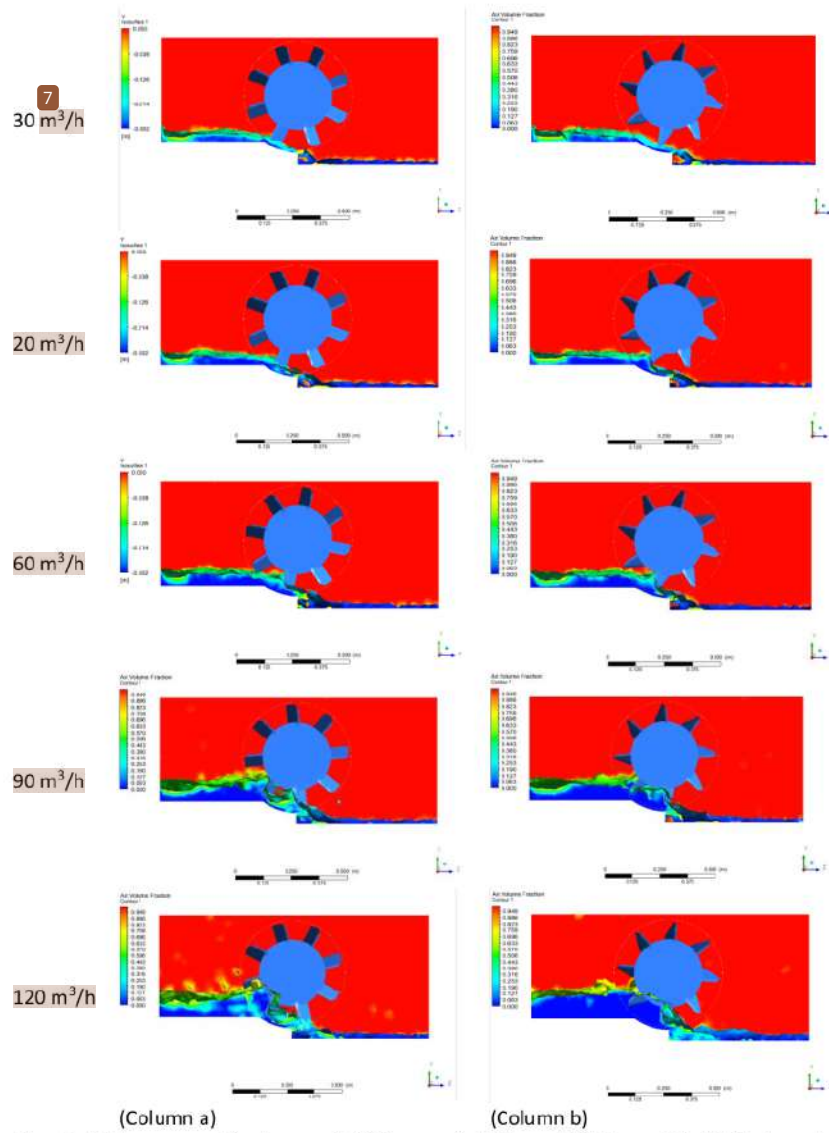

(Column a) (Column b)  
**Fig. 9.** Water mass discharge of (Column a) DW and (Column b) dDW at water discharges of 20, 30, 60, 90 and 120 m<sup>3</sup>/h



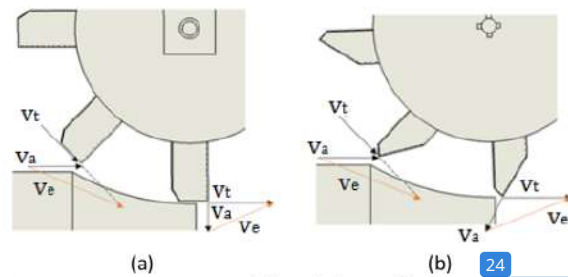

Fig. 10. Forces on DW (a) and dDW (b),  $v_t$  is tangential velocity,  $v_a$  is the inlet velocity of water, and  $v_e$  is an effective velocity

#### 4. Conclusions

Although the head height in irrigation canals is usually relatively low, the energy possessed by the flow of water in irrigation canals has not been fully exploited, even though the energy potential is sufficiently large, especially in areas with hilly terrain. Thus, proper tools are needed to convert the flow of water energy into electrical energy. One tool that is simple and easy to manufacture is the Dethridge wheel.

Therefore, several developments pertaining to the Dethridge wheel blade have been conducted to improve its performance. The experimental results show that the shape of the waterwheel blade affects the power and efficiency. The developed Dethridge wheel utilises a blade shape that allows water to push continuously until the blade leaves the canal bed, causing larger forces for a longer duration, which consequently impacts power and efficiency. The highest efficiency of the Dethridge wheel was found to be 55.56%, while that of the developed Dethridge wheel was 71.72%. Thus, the developed Dethridge wheel increases efficiency by 29% at 30 m<sup>3</sup>/h. CFD results are also in agreement with the experiment.

3

#### Acknowledgement

This research was funded by a grant from Lemlitbang UHAMKA and supported by the Office of UPPi at Universitas Muhammadiyah Prof. Dr. Hamka.

#### References

- [1] British Petroleum. "BP statistical review of world energy June 2013." London: British Petroleum (2013).
- [2] International Energy Agency. "Electricity information: Overview (2020 edition)." IEA (2020).
- [3] Lubis, Hamzah. "Renewable Energy of Rice Husk for Reducing Fossil Energy in Indonesia." *Journal of Advanced Research in Applied Sciences and Engineering Technology* 11, no. 1 (2018): 17-22.
- [4] Ngowi, Joseph M., Lennart Bångens, and Erik O. Ahlgren. "Benefits and challenges to productive use of off-grid rural electrification: The case of mini-hydropower in Bulongwa-Tanzania." *Energy for Sustainable Development* 53 (2019): 97-103. <https://doi.org/10.1016/j.esd.2019.10.001>
- [5] Harlan, Tyler. "Rural utility to low-carbon industry: Small hydropower and the industrialization of renewable energy in China." *Geoforum* 95 (2018): 59-69. <https://doi.org/10.1016/j.geoforum.2018.06.025>
- [6] Muhammadu, M. M., and J. Usman. "Small Hydropower Development in North-Central of Nigeria: An Assessment." *Journal of Advanced Research in Applied Mechanics* 69, no. 1 (2020) 7-16. <https://doi.org/10.37934/aram.69.1.716>
- [7] Amran, Mohd Effendi, Mohd Nabil Muhtazaruddin, and Habibah@Norehan Haron. "Renewable Energy Optimization Review: Variables towards Competitive Advantage in Green Building Development." *Progress in Energy and Environment* 8 (2019): 1-15.
- [8] Choudhury, Shibabrata, Adikanda Parida, Rajive Mohan Pant, and Saibal Chatterjee. "GIS augmented computational intelligence technique for rural cluster electrification through prioritized site selection of micro-

- hydro power generation system." *Renewable Energy* 142 (2019): 487-496. <https://doi.org/10.1016/j.renene.2019.04.125>
- [9] Lubis, Abubakar. "Energi terbarukan dalam pembangunan berkelanjutan." *Jurnal Teknologi Lingkungan* 8, no. 2 (2007).
- [10] Ueda, Tatsuki, Masahiro Goto, Atsushi Namihira, and Yuichi Hirose. "Perspectives of small-scale hydropower generation using irrigation water in Japan." *Japan Agricultural Research Quarterly: JARQ* 47, no. 2 (2013): 135-140. <https://doi.org/10.6090/jarq.47.135>
- [11] Butera, Ilaria, and Roberto Balestra. "Estimation of the hydropower potential of irrigation networks." *Renewable and Sustainable Energy Reviews* 48 (2015): 140-151. <https://doi.org/10.1016/j.rser.2015.03.046>
- [12] Koç, Cengiz. "A study on operation problems of hydropower plants integrated with irrigation schemes operated in Turkey." *International Journal of Green Energy* 15, no. 2 (2018): 129-135. <https://doi.org/10.1080/15435075.2018.1427591>
- [13] Kadir, Abudukeremu, Mohd Sahaid Kalil, Manoj Pudukudy, Hassimi Abu Hasan, Azah Mohamed, and Aidil Abdul Hamid. "Pico hydropower (PHP) development in Malaysia: Potential, present status, barriers and future perspectives." *Renewable and Sustainable Energy Reviews* 81 (2018): 2796-2805. <https://doi.org/10.1016/j.rser.2017.06.084>
- [14] Williamson, Samuel J., W. David Lubitz, Arthur A. Williams, Julian D. Booker, and Joseph P. Butchers. "Challenges Facing the Implementation of Pico-Hydropower Technologies." *Journal of Sustainability Research* 2, no. 1 (2019). <https://doi.org/10.20900/jsr20200003>
- [15] Balkhair, Khaled S., and Khalil Ur Rahman. "Sustainable and economical small-scale and low-head hydropower generation: A promising alternative potential solution for energy generation at local and regional scale." *Applied Energy* 188 (2017): 378-391. <https://doi.org/10.1016/j.apenergy.2016.12.012>
- [16] Siswantara, Ahmad Indra, Budiarmo Budiarmo, Aji Putro Prakoso, Gun Gun R. Gunadi, Warjito Warjito, and Dendy Adanta. "Assessment of turbulence model for cross-flow pico hydro turbine numerical simulation." *CFD Letters* 10, no. 2 (2018): 38-48.
- [17] Bozorgi, A., E. Javidpour, A. Riasi, and A. Nourbakhsh. "Numerical and experimental study of using axial pump as turbine in pico hydropower plants." *Renewable Energy* 53 (2013): 258-264. <https://doi.org/10.1016/j.renene.2012.11.016>
- [18] Tevata, Anurat, and Chainarong Inprasit. "The effect of paddle number and immersed radius ratio on water wheel performance." *Energy Procedia* 9 (2011): 359-365. <https://doi.org/10.1016/j.egypro.2011.09.039>
- [19] Paudel, Shakun, Martin Weber, Dirk Geyer, and Nicole Saenger. "Zuppinger water wheel for very low-head hydropower application." In *10th International Conference on Sustainable Energy and Environment Protection: Marine and Hydro Power*, pp. 25-34. University of Maribor Press, 2017. [https://doi.org/10.18690/978-961-286-055-4\\_3](https://doi.org/10.18690/978-961-286-055-4_3)
- [20] Quaranta, Emanuele, and Gerald Müller. "Optimization of undershot water wheels in very low and variable flow rate applications." *Journal of Hydraulic Research* 58, no. 5 (2020): 845-849. <https://doi.org/10.1080/00221686.2019.1671508>
- [21] Senior, James, Nicole Saenger, and Gerald Müller. "New hydropower converters for very low-head differences." *Journal of Hydraulic Research* 48, no. 6 (2010): 703-714. <https://doi.org/10.1080/00221686.2010.529301>
- [22] Paudel, Shakun, and Nicole Saenger. "Dethridge wheel for pico-scale hydropower generation: An experimental and numerical study." In *IOP Conference Series: Earth and Environmental Science*, vol. 49, no. 10, p. 102007. IOP Publishing, 2016. <https://doi.org/10.1088/1755-1315/49/10/102007>
- [23] Paudel, Shakun, and Nicole Saenger. "Effect of channel geometry on the performance of the Dethridge water wheel." *Renewable Energy* 115 (2018): 175-182. <https://doi.org/10.1016/j.renene.2017.08.043>
- [24] Mugisidi, Dan, Oktarina Heriyani, Rizal Andi Luhung, and Moh Ramdani Dwi Andrian. "Utilization of the dethridge wheel as a low head power generator and loss analysis." In *MATEC Web of Conferences*, vol. 204, p. 04003. EDP Sciences, 2018. <https://doi.org/10.1051/mateconf/201820404003>
- [25] Effendy, Effendy. "Disain Saluran Irigasi." *Pilar: Jurnal Teknik Sipil Politeknik Negeri Sriwijaya* 7, no. 2 (2012).
- [26] Boli, Rahmat, Abdul Makhsum, and Mahmuddin Tahir. "Analisis Daya Output dan Efisiensi Kincir Air Sudu Miring yang Bekerja pada Saluran Horizontal." *Gorontalo Journal of Infrastructure and Science Engineering* 1, no. 2 (2018): 1-7. <https://doi.org/10.32662/gojise.v1i2.423>
- [27] Denny, Mark. "The efficiency of overshot and undershot waterwheels." *European Journal of Physics* 25, no. 2 (2003): 193. <https://doi.org/10.1088/0143-0807/25/2/006>
- [28] Tu, Jiyuan, Guan Heng Yeoh, and Chaoqun Liu. *Computational fluid dynamics: a practical approach*. Butterworth-Heinemann, 2018.

- [29] Cleynen, Olivier, Emeel Kerikous, Stefan Hoerner, and Dominique Thévenin. "Characterization of the performance of a free-stream water wheel using computational fluid dynamics." *Energy* 165 (2018): 1392-1400. <https://doi.org/10.1016/j.energy.2018.10.003>
- [30] Çengel, Yunus A., and John M. Cimbala. *Fluid Mechanics Fundamentals and Applications (3rd Edition in SI Units)*. McGraw Hill, 2013.
- [31] Vidali, Cristina, Stefano Fontan, Emanuele Quaranta, Paolo Cavagnero, and Roberto Revelli. "Experimental and dimensional analysis of a breastshot water wheel." *Journal of Hydraulic Research* 54, no. 4 (2016): 473-479. <https://doi.org/10.1080/00221686.2016.1147499>
- [32] Mugjidi, Dan, Oktarina Heriyani, Rizal Andi Luhung, and Moh Ramdani Dwi Andrian. "Utilization of the dethridge wheel as a low head power generator and loss analysis." In *MATEC Web of Conferences*, vol. 204, p. 04003. EDP Sciences, 2018. <https://doi.org/10.1051/mateconf/201820404003>
- [33] Quaranta, Emanuele. "Stream water wheels as renewable energy supply in flowing water: Theoretical considerations, performance assessment and design recommendations." *Energy for Sustainable Development* 45 (2018): 96-109. <https://doi.org/10.1016/j.esd.2018.05.002>
- [34] Muliawan, Arief, and Ahmad Yani. "Analisis daya dan efisiensi turbin air kinetis akibat perubahan putaran runner." *Sainstek: Jurnal Sains dan Teknologi* 8, no. 1 (2017): 1-9. <https://doi.org/10.31958/js.v8i1.434>
- [35] Yani, Ahmad, Mihdar Mihdar, and Rudi Erianto. "Pengaruh Variasi Bentuk Sudu Terhadap Kinerja Turbin Air Kinetik (Sebagai Alternatif Pembangkit Listrik Daerah Pedesaan)." *Turbo: Jurnal Program Studi Teknik Mesin* 5, no. 1 (2017). <https://doi.org/10.24127/trb.v5i1.113>
- [36] Bahaj, A. S., A. F. Molland, J. R. Chaplin, and W. M. J. Batten. "Power and thrust measurements of marine current turbines under various hydrodynamic flow conditions in a cavitation tunnel and a towing tank." *Renewable Energy* 32, no. 3 (2007): 407-426. <https://doi.org/10.1016/j.renene.2006.01.012>
- [37] Prabowo, Boy Ilham, and Priyo Heru Adiwibowo. "Eksperimental Kinerja Turbin Reaksi Aliran Vortex Tipe Sudu Berpenampang L Dengan Variasi Panjang Sisi Lurus Pada Ujung Sudu." *Jurnal Teknik Mesin* 6, no. 1 (2018): 115-123.
- [38] Müller, G., and Christian Wolter. "The breastshot waterwheel: design and model tests." In *Proceedings of the Institution of Civil Engineers-Engineering Sustainability*, vol. 157, no. 4, pp. 203-211. Thomas Telford Ltd, 2004. <https://doi.org/10.1680/ensu.2004.157.4.203>
- [39] Zaman, Ayesha, and Taslima Khan. "Design of a water wheel for a low head micro hydropower system." *Journal Basic Science and Technology* 1, no. 3 (2012): 1-6.
- [40] Nguyen, Manh Hung, Haechang Jeong, and Changjo Yang. "A study on flow fields and performance of water wheel turbine using experimental and numerical analyses." *Science China Technological Sciences* 61, no. 3 (2018): 464-474. <https://doi.org/10.1007/s11431-017-9146-9>
- [41] Anam, Asroful, Rudy Soenoko, and Denny Widhiyanuriyawan. "Pengaruh variasi sudut input sudu mangkok terhadap kinerja turbin kinetik." *Jurnal Rekayasa Mesin* 4, no. 3 (2014): 199-203.
- [42] Adanta, Dendy, Satrio Adi Arifianto, and Sanjaya BS Nasution. "Effect of blades number on undershot waterwheel performance with variable inlet velocity." In *2018 4th International Conference on Science and Technology (ICST)*, pp. 1-6. IEEE, 2018.

# Dan Mugisidi - Development of the Dethridge Wheel Blade Shape for Hydropower Generation in Irrigation Canals in Indonesia

## ORIGINALITY REPORT

12%

SIMILARITY INDEX

10%

INTERNET SOURCES

3%

PUBLICATIONS

1%

STUDENT PAPERS

## PRIMARY SOURCES

1	<a href="http://silo.pub">silo.pub</a> Internet Source	2%
2	<a href="http://iopscience.iop.org">iopscience.iop.org</a> Internet Source	1%
3	<a href="http://umexpert.um.edu.my">umexpert.um.edu.my</a> Internet Source	1%
4	Submitted to University of Illinois at Urbana-Champaign Student Paper	1%
5	<a href="http://www.econstor.eu">www.econstor.eu</a> Internet Source	1%
6	<a href="http://repository.uhamka.ac.id">repository.uhamka.ac.id</a> Internet Source	1%
7	<a href="http://www.bad-saulgau.de">www.bad-saulgau.de</a> Internet Source	1%
8	<a href="http://ejournal.radenintan.ac.id">ejournal.radenintan.ac.id</a> Internet Source	<1%

9	<a href="http://www.thaiscience.info">www.thaiscience.info</a> Internet Source	<1 %
10	<a href="http://www.mdpi.com">www.mdpi.com</a> Internet Source	<1 %
11	Emanuele Quaranta, Roberto Revelli. "CFD simulations to optimize the blades design of water wheels", Copernicus GmbH, 2017 Publication	<1 %
12	Jamal A. Hameed, Amer T Saeed, Mugdad H. Rajab. "Design and Study of Hydroelectric Power Plant by Using Overshot and Undershot Waterwheels", International Journal of Energy Optimization and Engineering, 2019 Publication	<1 %
13	<a href="http://gurutraders.successfinancialfreedom.com">gurutraders.successfinancialfreedom.com</a> Internet Source	<1 %
14	Daqing Zhou, Jia Gui, Zhiqun Daniel Deng, Huixiang Chen, Yunyun Yu, An Yu, Chunxia Yang. "Development of an ultra-low head siphon hydro turbine using computational fluid dynamics", Energy, 2019 Publication	<1 %
15	<a href="http://archive.nlm.nih.gov">archive.nlm.nih.gov</a> Internet Source	<1 %
16	<a href="http://ejournal.unesa.ac.id">ejournal.unesa.ac.id</a> Internet Source	<1 %

<1 %

17

[ijrer.org](http://ijrer.org)

Internet Source

<1 %

18

[link.springer.com](http://link.springer.com)

Internet Source

<1 %

19

[odr.chalmers.se](http://odr.chalmers.se)

Internet Source

<1 %

20

[open.uct.ac.za](http://open.uct.ac.za)

Internet Source

<1 %

21

[revistas.tec.ac.cr](http://revistas.tec.ac.cr)

Internet Source

<1 %

22

[www.ajbasweb.com](http://www.ajbasweb.com)

Internet Source

<1 %

23

[www.science.gov](http://www.science.gov)

Internet Source

<1 %

24

[www.tandfonline.com](http://www.tandfonline.com)

Internet Source

<1 %

25

[www.uni-flensburg.de](http://www.uni-flensburg.de)

Internet Source

<1 %

Exclude quotes Off

Exclude matches Off

Exclude bibliography On