

PAPER • OPEN ACCESS

Committee

To cite this article: 2019 *J. Phys.: Conf. Ser.* **1373** 011001

View the [article online](#) for updates and enhancements.

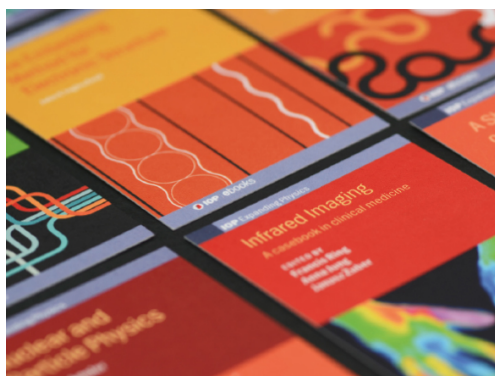

IOP | ebooks™

Bringing together innovative digital publishing with leading authors from the global scientific community.

Start exploring the collection—download the first chapter of every title for free.

Committee**Editor in Chief**

Asst. Prof. Damar Yoga Kusuma, Ph.D. (Universitas Ahlamd Dahlan)

Editors

Asst. Prof. Afroz Ahmad Shah, Ph.D. (Universiti Brunei Darussalam)

Dr. Abhishek Kumar (Solar Energy Research Institute of Singapore)

Prof. Darsono Bahrun (Center for Science and Accelerator Technology)

Dr. Hanik Humaida (Center for Volcanology and Geological Hazard Mitigation)

Qonitatul Hidayah, M.Sc. (Universitas Ahlamd Dahlan)

Nursyiva Irsalinda, M.Sc. (Universitas Ahlamd Dahlan)

Iwan Tri Riyadi Yanto, M.I.T (Universitas Ahlamd Dahlan)

Joko Purwadi, M.Sc. (Universitas Ahlamd Dahlan)

Scientific Committee

Prof. Dahelmi – Universitas Andalas (Scopus ID: [56152808500](#))

Prof. Darsono Bahrun – National Agency for Nuclear Power (Scopus ID: [55367047200](#))

Prof. Dyah Aryani Perwitasari – Universitas Ahmad Dahlan (Scopus ID: [36114858900](#))

Prof. Eti Yerizel – Universitas Andalas (Scopus ID: [57190031424](#))

Prof. Hariyadi – Universitas Ahmad Dahlan (Scopus ID: [8833969200](#))

Prof. John A. Carver – Australian National University (Scopus ID: [7102839510](#))

Prof. Khrishna P. Candra – Universitas Mulawarman (Scopus ID: [57196435267](#))

Prof. Lee Pooi See – Nanyang Technological University (Scopus ID: [7406117427](#))

Prof. Maizatul Akmar binti Ismail – University Malaya (Scopus ID: [25825070200](#))

Prof. Setyawan P. Sakti – Universitas Brawijaya (Scopus ID: [6507450797](#))

Assoc. Prof. Anton Yudhana – Universitas Ahmad Dahlan (Scopus ID: [36660093000](#))

Assoc. Prof. Budi Purnama – Universitas Sebelas Maret (Scopus ID: [16029748100](#))

Assoc. Prof. Fajar Adi Kusumo – Universitas Gadjah Mada (Scopus ID: [24480624100](#))

Assoc. Prof. Jason J. Jung – Chung-Ang University, South Korea (Scopus ID: [7402896966](#))

Assoc. Prof. Kitichate Sridith – Prince of Songkla University (Scopus ID: [6506521909](#))

Assoc. Prof. Kuwat Triyana – Universitas Gadjah Mada (Scopus ID: [8597558700](#))

Assoc. Prof. Lydia Helena Wong – Nanyang Technological University

(Scopus ID: [12041027200](#))

Assoc. Prof. Maelita R. Moeis – Institut Teknologi Bandung (Scopus ID: [35776885000](#))

Assoc. Prof. Moh Edi Wibowo – Universitas Gadjah Mada (Scopus ID: [54975678100](#))

Assoc. Prof. Nurkhasanah – Universitas Ahmad Dahlan (Scopus ID: [56610264900](#))

Assoc. Prof. Raju K. Gupta – Indian Institute of Technology Kanpur

(Scopus ID: [37009709600](#))

Assoc. Prof. Rino A. Nugroho – Universitas Sebelas Maret (Scopus ID: [57190759643](#))

Assoc. Prof. Risa Suryana – Universitas Sebelas Maret (Scopus ID: [14523651300](#))

Assoc. Prof. Suparman – Universitas Ahmad Dahlan (Scopus ID: [6507107541](#))

Assoc. Prof. Thomas Reindl, Solar Energy Research Institute of Singapore

(Scopus ID: [6603154919](#))

Assoc. Prof. Yan Jian – Hefei University of Technology (Scopus ID: [55262372600](#))



- Asst. Prof. Afroz Ahmad Shah – Universiti Brunei Darussalam (Scopus ID: [55511747410](#))
Asst. Prof. Damar Yoga Kusuma – Universitas Ahmad Dahlan (Scopus ID: [36618892400](#))
Asst. Prof. Edi Suharyadi – Universitas Gadjah Mada (Scopus ID: [9737294200](#))
Asst. Prof. Imam Riadi – Universitas Ahmad Dahlan (Scopus ID: [55847330600](#))
Asst. Prof. Irwan Endrayanto – Universitas Gadjah Mada (Scopus ID: [6506191432](#))
Asst. Prof. M. Andri Setiawan – Universitas Islam Indonesia (Scopus ID: [36662875500](#))
Dr. Arief Budi Witarto – Universitas Teknologi Sumbawa (Scopus ID: [6507004235](#))
Dr. Afriyanti Sumboja – Institut Teknologi Bandung (Scopus ID: [36005012700](#))
Dr. Agus Sukarto Wismogroho – Indonesian Institute of Science (Scopus ID: [6503938346](#))
Dr. dr. Akrom – Universitas Ahmad Dahlan, Indonesia (Scopus ID: [57195033992](#))
Dr. Arfika Nurhudatiana – Universitas Bina Nusantara (Scopus ID: [54912091600](#))
Dr. Bramasta Nugraha – University of Zurich, Switzerland (Scopus ID: [36128806300](#))
Dr. Fatwa Firdaus Abdi – Helmholt Zentrum Berlin (Scopus ID: [55204686600](#))
Dr. Firdaus Prabowo – HydroVision Asia (Scopus ID: [36338122900](#))
Dr. Hasmiwati – Universitas Andalas, Indonesia (Scopus ID: [56907034000](#))
Dr. Karlia Meitha – Institut Teknologi Bandung, Indonesia (Scopus ID: [56868559900](#))
Dr. Lin Meng Fang – Cranfield University (Scopus ID: [37040732800](#))
Dr. Hanik Humaida – Ministry of Energy and Mineral Resource (Scopus ID: [55341598700](#))
Dr. Kok Poh Heng – University Malaysia Terengganu (Scopus ID: [56890761400](#))
Dr. Novan Tofany – National University of Singapore (Scopus ID: [36613520800](#))
Dr. Rahmat Agung Susyantoko – Khalifa University of Science and Technology
(Scopus ID: [55948386000](#))
Dr. Reyhan Muhammad – King Abdullah University of Science and Technology
(Scopus ID: [36630713400](#))
Dr. Rita Maliza – Universitas Ahmad Dahlan (Scopus ID: [56181685900](#))
Dr. Subiyanto – Universitas Padjajaran (Scopus ID: [55354686500](#))
Dr. Teguh Citra Asmara – National University of Singapore (Scopus ID: [55765361800](#))
Dr. Vijay Kumar Thakur – Cranfield University (Scopus ID: [23977355000](#))
Dr. Warsito Purwo Taruno – CTECH Laboratory, Indonesia (Scopus ID: [55598345200](#))
Aceng Sambas – Universitas Muhammadiyah Tasikmalaya (Scopus ID: [55536627700](#))
Ali Ashikin – University Tun Husein Onn (Scopus ID: [54976790900](#))
Deden Witarasyah Jacob – Telkom University (Scopus ID: [57192986806](#))
Edi Sutoyo – Telkom University, Indonesia (Scopus ID: [56377194700](#))
Iwan Tri Riyadi Yanto – Universitas Ahmad Dahlan, Indonesia (Scopus ID: [35316618700](#))
Nursyiva Irsalinda – Universitas Ahmad Dahlan (Scopus ID: [57192984454](#))
Rd. Rohmad Saedudin – Telkom University (Scopus ID: [56436586900](#))
Wareesa Syarif – University Tun Husein Onn (Scopus ID: [57193625601](#))

PAPER • OPEN ACCESS

Table of Content

To cite this article: 2019 *J. Phys.: Conf. Ser.* **1373** 011003

View the [article online](#) for updates and enhancements.



IOP | ebooks™

Bringing together innovative digital publishing with leading authors from the global scientific community.

Start exploring the collection—download the first chapter of every title for free.

Table of Content**The 2019 Conference on Fundamental and Applied Science for Advanced Technology
(ConFAST 2019)**

Topic	First Author Surname	Paper Title
A. Maritime, Oceanic, and Atmospheric Science	Hasibuan	Prediction System of Carbon Monoxide Toxic Gas Monitoring Using Double Moving Average Method
	Hermawan	Characteristics of the Extreme Rainfall over Indonesian Equatorial Region based on the Madden-Julian Oscillation Index Data Analysis
	Rahayu	Analysis for Radiosonde Temperature profile Measurement in Pamengpeuk
	Sipayung	Analysis of Drought Potential in Sumbawa Island Until 2040 Caused by Climate Change
	Syahputra	Analytical Hierarchy Process (AHP) in Selecting Suitable Marine Protecting Area (MPA) site in Pulo Breuh (Breuh Island), Indonesia
B. Sustainable Energy and Smart Materials	Alimny	Kinetics of Reducing Sugar Formation from Coconut Husk by Subcritical Water Hydrolysis
	Ardian	Experimental Test of the Effect of Wet Ethanol on Decreasing Emission Exhaust in EFI Gasoline Engine with EGR Systems
	Ardiles	Maximizing Power Tracking of an Offshore Wind Turbine Using Perturb and Observe Method
	Faoji	Effect of Wet-Ethanol on Fuel Consumption and Soot Emissions on Direct Injection Diesel Engines with Jatropa and Solar Cold EGR System
	Firmansyah	Effect of Water Content in Methanol on the Performance and Exhaust Emissions of Direct Injection Diesel Engines Fueled by Diesel Fuel and Jatropa Oil Blends with EGR System
	Firmansyah	Comparison of Hi-Art Tomotherapy Machine Outputs Using AAPM TG-148 and IAEA TRS 483 Codes of Practice
	Heriyani	Performance of Dethridge Wheel as a Low Head Power Generator and Loss Analysis
	Khansa	Deposition Time Variation on Thickness and Resistivity of Cu/Ni Thin Film Obtained by Magnetic Field-Assisted Electroplating Process
	Mugisidi	The Effect of Water Surface Level in Sensible Heat Material on Yield of Single Basin Solar Still: Experimental Study
	Muslim	Harmonic Analysis of Ionospheric Total Electron Content (TEC) Using Kalman Filter



	Nasori	Comparative Study of p-type Photocathode CuBi ₂ O ₄ Films and CuBi ₂ O ₄ Nanopillars Photocathode for High Performance Photoelectrochemical Water Splitting
	Rakino	A Passive Cooling System for Increasing Efficiency of Solar Panel Output
	Rafiqoh	Effect of Temperature in Ionic Liquids Pretreatment on Structure of Lignocellulose from Corncob
	Sanjaya	Effect of Premium-Butanol Blends on Fuel Consumption and Emissions on Gasoline Engine with Cold EGR Systems
	Sinaga	Experimental and Computational Study on Heat Transfer of a 150 kW Air Cooled Eddy Current Dynamometer
	Sinaga	Numerical Simulation of the Width and Angle of the Rotor Blade on the Air Flow Rate of a 350 kW Air-Cooled Eddy Current Dynamometer
	Surya	Enhancements in Cure Rate Index and Mechanical Properties of Silica-Filled Natural Rubber Using Octadecanol-Fatty Alcohol
	Surya	The cure and tensile properties of montmorillonite-natural rubber composites in the incorporation of alkanolamide
	Syahbardia	Study of Desiccant Rice Husk Ash for Air Conditioning System
	Tarigan	The Effect of Dust on Solar PV System Energy Output Under Urban Climate of Surabaya, Indonesia
	Tresnawati	Sensor Fabrication for Determination of Cadmium Using Nafion/Ionic Liquid/Graphene Composite with Thick Film Technology
	Triwikantoro	The Crystallization Process of Zr-Based Metallic Glass by the Influence of Heating Rate and Alloy Composition
	Utomo	The Real Time Vital Sign Monitor for Heart Rate and SPO ₂ Parameter Using Internet of Things Technology
	Wustha	Thickness and Resistivities of Cu/Ni Film Resulted by Electroplating on the Various Electrolyte Temperature
D. Environmental Science and Disaster Management	Danardono	Potential of Carbon Stocks and Its Economic Values in Tropical Karst Landscape (Case Study in Biduk-Biduk Karst, East Kalimantan, Indonesia)
	Lestari	Earthquake Risk Reduction Study with Mapping an Active Fault at the Southern of East Java
	Muriyatmoko	Landslide Prone Maps Using Weighting Parameters in Pulung, Ponorogo East Java
E. Intelligent Systems in Informatics and Computing	Afnia	The Valuation of Deposit Insurance with Risk Using Fourier Transform
	Albab	Forecasting of Vannamei Shrimp Production Based on Weather Factors Using Radial Basis Function Neural Network Approach (Case Study: Lamongan District)
	Ardiansyah	Determination Of Location And Numbers Of Monorail Stops In Surabaya With Max Covering Problem Model
	Barus	Web-Based Application Applying Newton Gregory Forward Method for Prediction of Closing Stock Prices

Cahyaningrum	Indonesian community welfare levels clustering using the fuzzy subtractive clustering (FCM) method
Fadlil	Mushroom Images Identification Using Orde 1 Statistics Feature Extraction with Artificial Neural Network Classification Technique
Fadlil	Mobile Forensics in Android Smartwatch
Harahap	Implementation of Cloudflare Hosting for Speeds and Protection on the website
Hidayati	Optimal Control of Dynamic IS-LM Business Cycle Model with Two Time Delays
Irfan	Development of Question Answering System Based on Ontology in Indonesian Traditional Medicinal Plants
Ma'arif	Application of Intelligent Search Algorithms in Proportional-Integral-Derivative Control of Direct-Current Motor System
Meliana	Identification of Cyber Bullying by Using Clustering Methods On Social Media Twitter
Nafi'Iyah	Fuzzy Features for Facial Shape Classification on Panoramic Dental Image
Purwanto	Digital Forensic Challenges Integrity data Point-of-Sale (POS) Cloud-based Software as a Service (SaaS)
Rahmawati	An Application of Stochastic Dominance with Truncated Normal Distribution on LQ45 Index
Rosnafian	Stability Analysis on the Spread of The Ebola Virus Considering Changes in Human Behaviour and Climate (Case Study in the Democratic Republic of the Congo)
Setiady	Design of Automatic Braking System Using Interval Type-2 Fuzzy Logic System
Sugiyanto	Indonesian Financial Crisis Prediction Using Combined Volatility and Markov Regime Switching Model Based on Indicators of Real Interest Rate on Deposits and Lending Interest Rate/Deposit Interest Rate
Suherman	Link quality decrement and spectrum crowded impacts to wireless local area network performances
Sukmarini	Minimizing Total Cost in Integrated Scheduling of Production and Distribution Using Ant Colony Optimization
Sunardi	Design and Development of Calculation System for Normalized Difference in Vegetation Index (NDVI) Using Landsat 8 Satellite Image
Surya	Identification of Pekalongan Batik Images Using Backpropagation Method
Triana	Exponential Distribution Parameter Estimation with Bayesian SELF Method in Survival Analysis
Triwiyanto	Investigation of The Number of Features and Muscles for an Effective Hand Motion Classifier Using Electromyography Signal
Uddin	Adaptive Trajectory Tracking Control System of Two-Wheeled Robot

	Yudhana	Development of Door Safety Fingerprint Verification Using Neural Network
	Yudhana	The Monitoring of Corn Sprouts Growth Using The Region Growing Methods

PAPER • OPEN ACCESS

The Effect of Water Surface Level in sensible heat material on Yield of Single Basin Solar Still: Experimental Study

To cite this article: Dan Mugisidi *et al* 2019 *J. Phys.: Conf. Ser.* **1373** 012014

View the [article online](#) for updates and enhancements.



IOP | ebooks™

Bringing you innovative digital publishing with leading voices to create your essential collection of books in STEM research.

Start exploring the collection - download the first chapter of every title for free.

The Effect of Water Surface Level in sensible heat material on Yield of Single Basin Solar Still: Experimental Study

Dan Mugisidi^{1,*}, Berkah Fajar², Tony Utomo², Syaiful²

¹Doctoral Programe, Department of Mechanical Engineering, Faculty of Engineering, Universitas Diponegoro, Indonesia

²Department of Mechanical Engineering, Faculty of Engineering, Universitas Diponegoro, Indonesia

*Email: dan.mugisidi@uhamka.ac.id

Abstract. The purpose of this experiment is to study the yield of the single basin solar still as an effect of water surface level in sensible heat material in a single basin solar still. The study is conducted on an open floor roof top at the Faculty of Engineering, Muhammadiyah University Prof. DR HAMKA in Jakarta, Indonesia. The study is conducted within two month and use 3 solar stills made of 3 mm Stainless Steel with dimensions 420 mm x 305 mm. The cover is made of 3 mm glass with a slope of 30 degrees. Iron sand that used as sensible heat material is taken from Glagah beach, Kulonprogo in Yogyakarta, Indonesia. 3 solar stills containing 20 mm height of iron sand. The height of the water in the three solar stills is 15mm (V1), 20mm (V2) and 25mm (V3) so that sequentially the surface of the water will be below the surface of the iron sand, the same as the surface of iron sand and above the surface of iron sand. The results obtained show that the daily yield accumulation of V2 is on average 49% higher than V1 while V3 is 57% higher above V1.

1. Introduction

Solar still is a simple device and only has 1 chamber to evaporate and condense basin water. The solar still is heated by the sun and the heat absorbed by the heat sink, then the heat is transferred to basin water. The hot water evaporates and then condense on the cover glass, expected to flow in the collecting gutter. The water that enters the collecting gutter will be channelled to the reservoir and already turned into fresh water.

Various methods and materials are used to improve the performance of solar still including Efforts to increase productivity are carried out using heat storage from sensible heat material. An experimental study use carbon powder performed charcoal particles is used as absorber medium and increase productivity as much as 15% [1]. El-Sebaili use sand as sensible storage material under basin liner [2]. Sand compare with servotherm medium oil is used as sensible heat storage material and placed beneath basin liner [3]. Carbon powder as a porous solar absorber inside solar still improve yield average 35% [4]. Sensible heat storage materials like quartzite rock, red brick pieces, cement concrete pieces, washed stones and iron scraps placed inside solar still [5]. The black jute clothes act as porous absorbers in basin water inside the solar still [6]. Extended porous fins made up of blackened old cotton rags are dipped partially inside the basin of the still [7]. The use of Portland cement black-blackened, as heat storage, increases freshwater production by 39% [8]. still. A modified solar using silica sand and layered with black coal powder at its surface compared with conventional solar still to study its heat and mass transfer



[9]. To our knowledge, no experimental research has been conducted using iron sand to enhance productivity of solar.

The present work is using iron sand as a porous absorber inside solar still. Since some study already prove that water level inside basin have significant influence [10] then it is motivate to vary water surface to become below, same level and above of iron sand surface to see its effect.

2. Experimental set up

Three single basins solar still are fabricated with stainless steel plate 2mm SUS304 and the cover use 3mm glass. Effective dimensions of the solar still 403mm x 305mm. At figure 1, all solar stills are filled with iron sand up to 20mm and basin water varied in height 15mm, 20mm, and 25mm, which are called V1, V2 and V3 respectively. Data was taken on August 19, 2018, August 29, 2018 and September 1 2018 starting at 08.00 to 17.00 without put solar radiation condition into account. Temperature was measured using the calibrated thermocouple type K, which has an accuracy of 0.1%, in 15 minutes interval. Digital anemometer 0 – 30 with interval 0,1 m/s was used to measure wind speed. The water level inside all solar still maintain at fix level using buffer tank outside the still. The iron content in iron sand varies depending on the area of mining, it can be 59.8% [11] to 76.35% [12]. In this experiment, the iron sand used content 70.3% of iron and was taken from Glagah beach, Kulonprogo in Yogyakarta, Indonesia. Pororsity of the iron sand is calculated using equation:

$$\phi = \frac{V_v}{V_t} \quad (1)$$

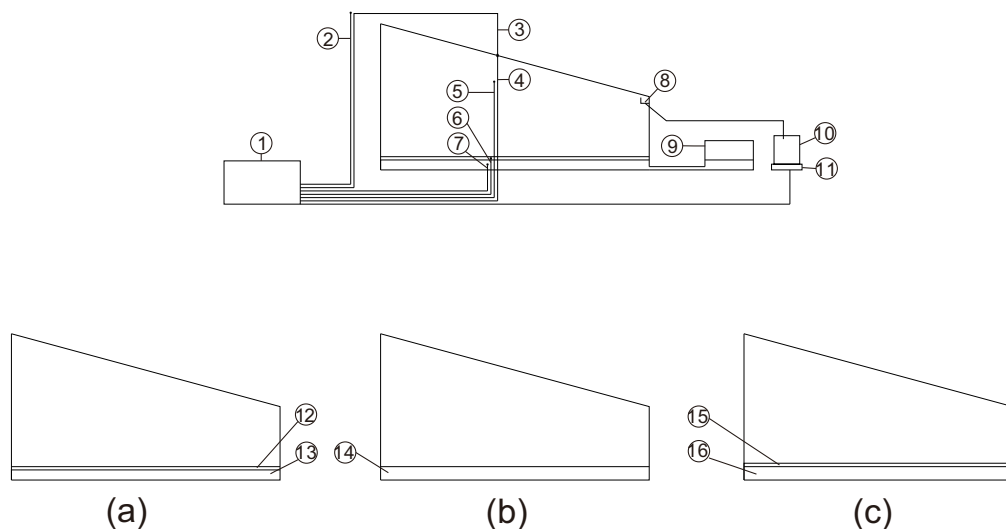

Figure 1. Single slope solar still contains ; (a) Iron sand 20mm height and basin water 15mm height namely V1, (b) Iron sand and basin water 20mm height namely V2, (c) Iron sand 20mm height and basin water 25mm height namely V3. 1 = Data Collector, 2 = Solar radiation sensor, 3 = Tgo Sensor, 4 = Tgi sensor, 5 = Tv sensor, 6 = Tw sensor, 7 = Ts sensor, 8 = Gutter, 9 = Water basin buffer, 10 = Fresh water collector, 11 = Weighing, 12 = Iron sand in V1, 13 = Mixed of water and iron sand in V1, 14 = Mixed of water and iron sand in V2, 15 = Basin water in V3, 16 = Mixed of water and iron sand in V3.

3. Result and discussion

Solar radiation and wind speed affect temperature and productivity of solar still [13]. As shown in figure 2, solar radiation and wind speed fluctuate all the time and it affect temperature in solar still. As can be

seen in figure 3 to figure 4, temperature inside the solar still is fluctuation and respond to solar radiation, eventhough the response is different for each type of solar still. Temperature profiles are shown on solar still V1, V2 and V3 has a profile like a bell shape even though solar radiation fluctuates this because the heat of solar radiation is absorbed by sensible heat material material and released when solar radiation drop [2][14].

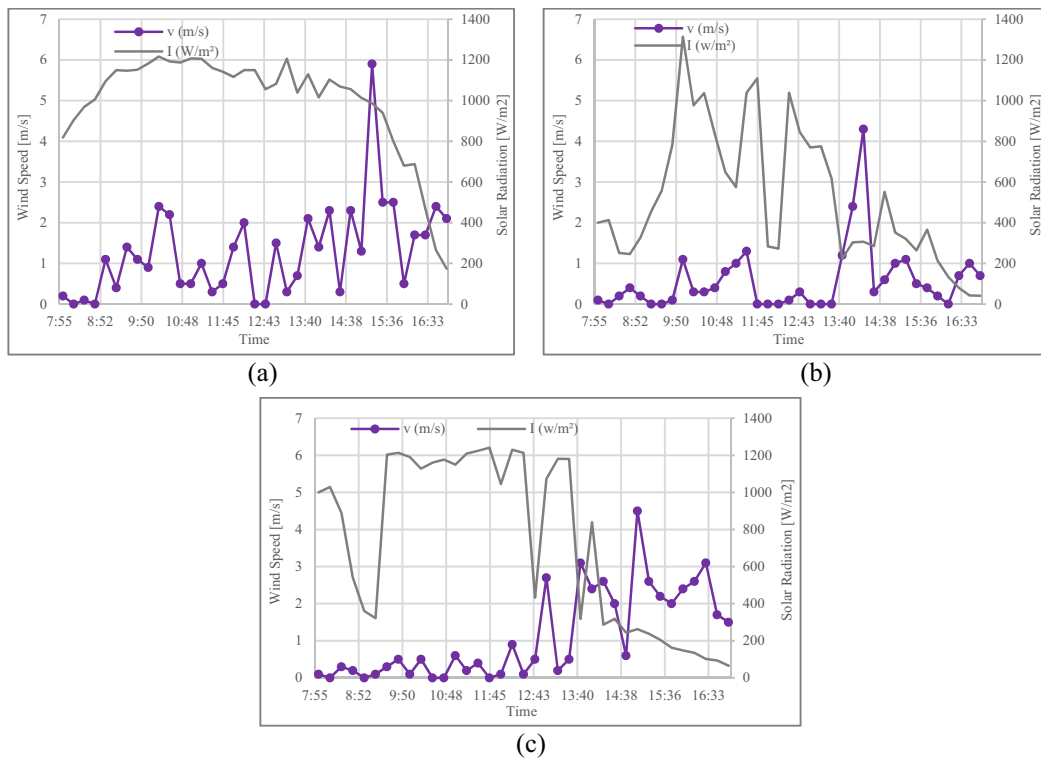

Figure 2. Solar radiation and wind speed at August 19, 2018 (a), August 29, 2018 (b) and September 1, 2018 (c).

In this study, water and sand were mixed. Thus, water temperature (T_a) and sand temperature (T_s) have a very similar temperature profile. At V1, the water surface is below the sand surface and the water temperature is lower than the sand temperature. In V3, the water surface is 5 mm above the sand surface and the water temperature is higher than the sand temperature. These results indicate that there is a gradient temperature due to the propagation of heat in the sand takes some time.

Daily accumulation yield can be seen at Fig 6. Although daily accumulation yield obtained is in accordance with solar radiation, the results follow a certain sequence, from the smallest V1, then V2 and the largest V3.

The level of water in V1 is lower than surface level of sensible heat material. The porosity of sensible heat material is 43.7% and the water rises to the surface with capillarity through the porosity of the material at the speed 0.34 mm/s. Since the surface area of the sensible heat material 1.57 times bigger than the area of solar still and the flow rate 0.0025 ml/s, the heat that accumulated on the surface of sensible heat material is not use to heat and evaporate the water but released. For comparison, the average evaporation rate of V3 is 0.0096 ml/s. That is the reason why the daily yield of V1 is lower than two others. Furthermore, since surface level of water as high as iron sand, part of iron sand particle is higher than water, so that heat accumulated on iron surface transfer to the basin water and air above it. As a result, daily yield of V2 is lower than V3, as shown in **Table 1**.

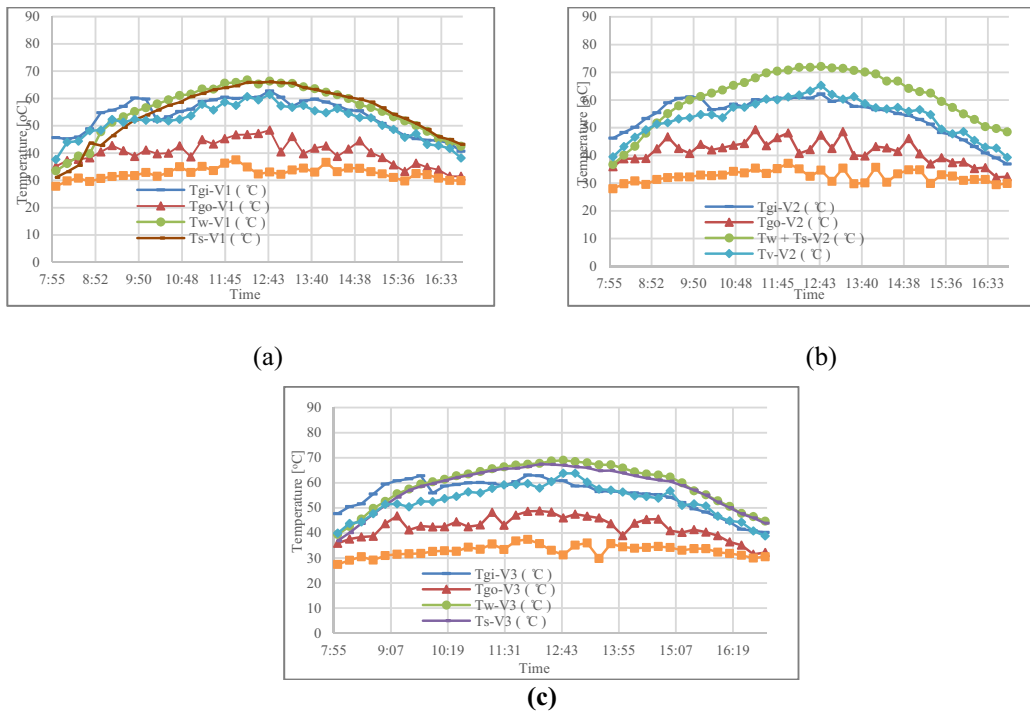

Figure 3. Experiment at August 19, 2018. Tgi=inside glass temperature, Tw=water temperature, Ta=ambient temperature, Tgo=outside glass temperature, Tv=vapour temperature, I=solar radiation

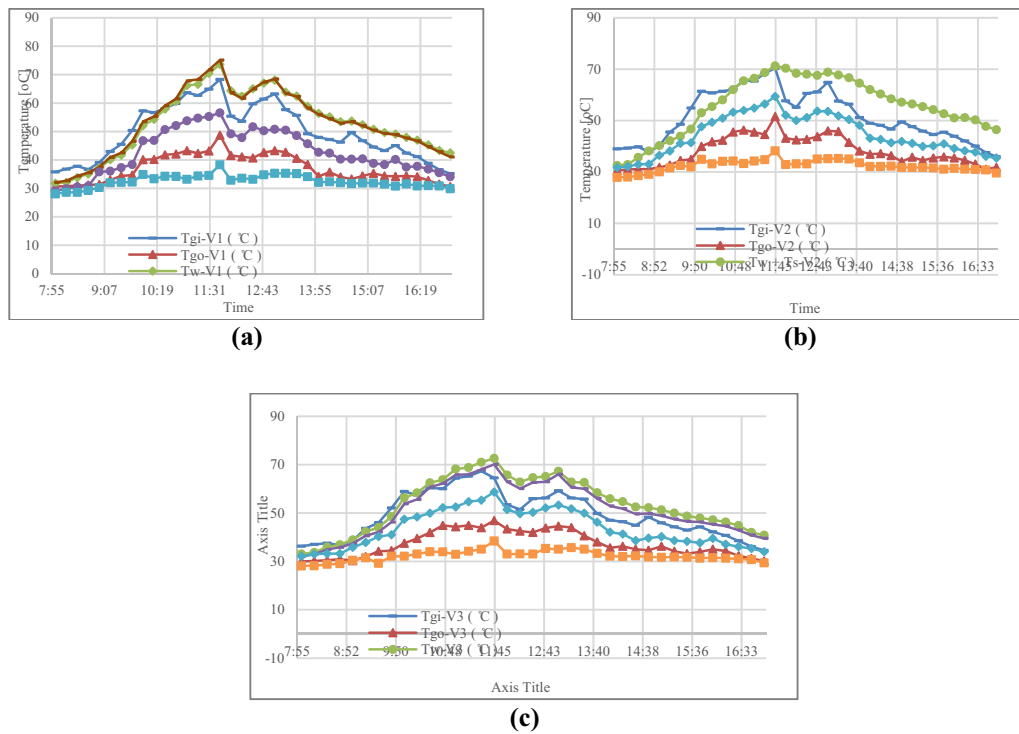

Figure 4. Experiment at August 29, 2018

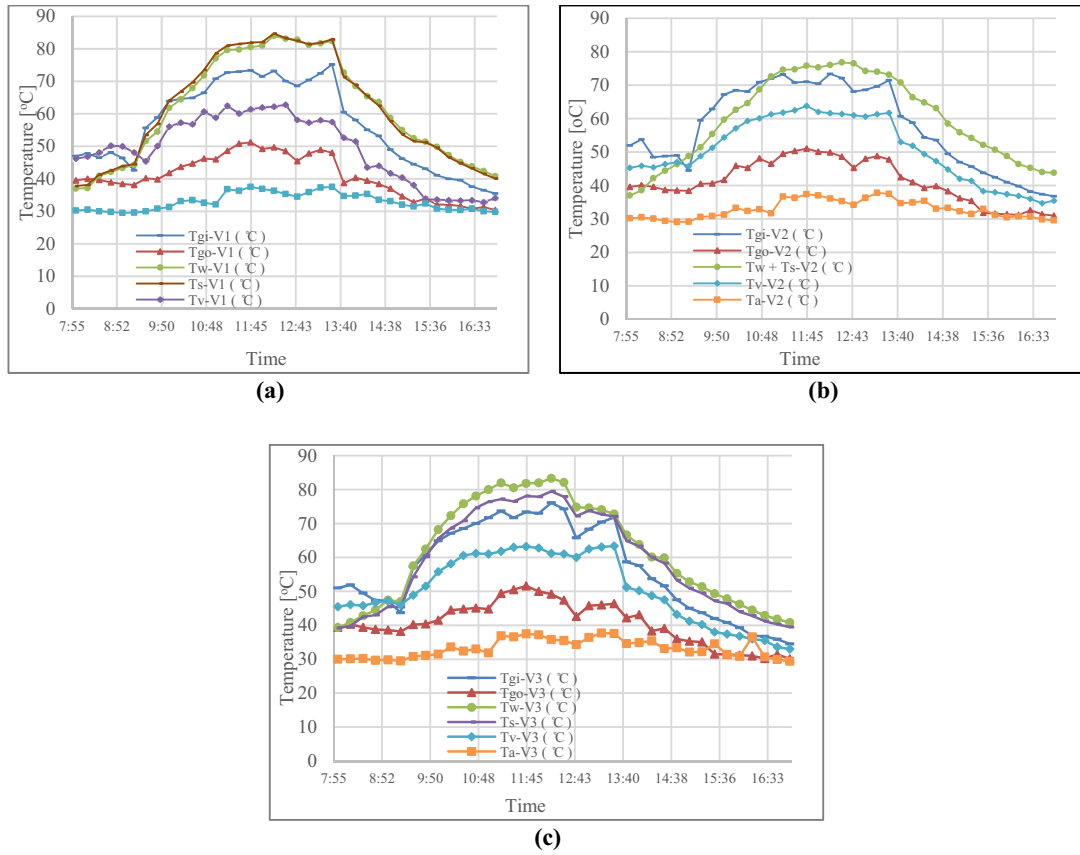

Figure 5. Experiment at September 1, 2018

TABLE 1. Daily yield of V1, V2 and V3

Date	V1 [gr/m ²]	V2 [gr/m ²]	V3 [gr/m ²]	ΣI [W/m ²]
19-Aug-18	925	2,175	2,450	36.933
29-Aug-18	392	667	708	19.056
1-Sep-18	500	958	1,125	26.811

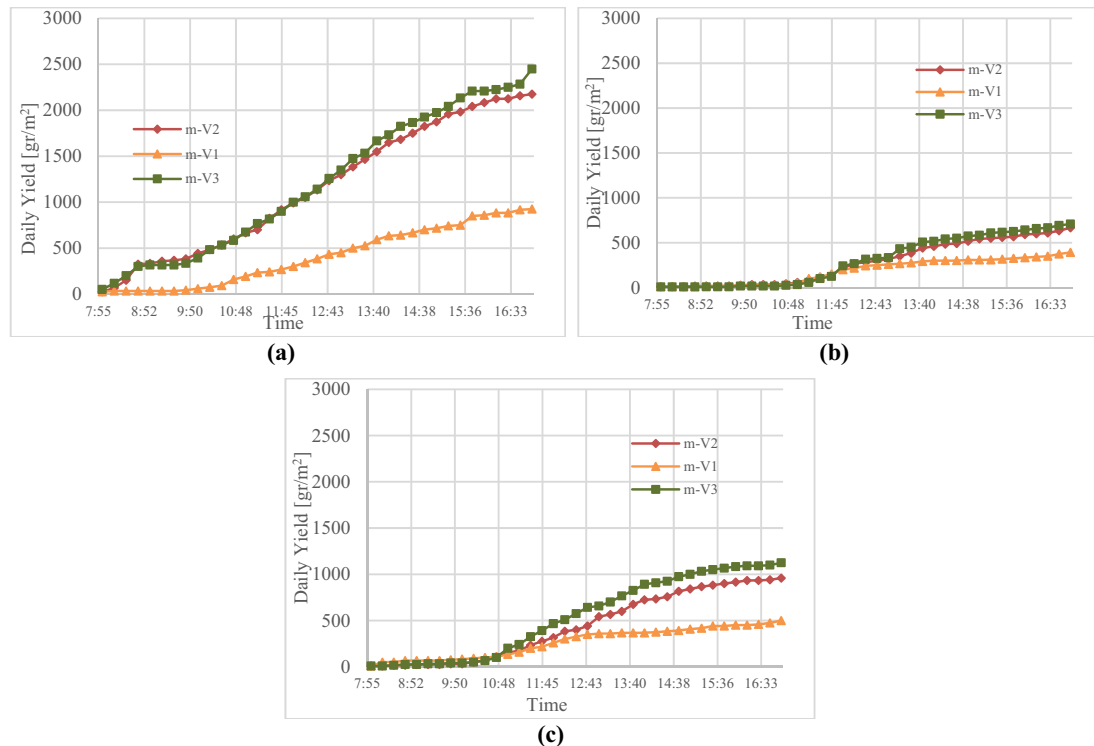

FIGURE 6. Daily yield of P, V1, V2 and V3 at August 19 (a), August 29 (b) and September 1, 2018 (c)

4. Conclusion

The experiment using iron sand as a sensible heat material material and functioned as an absorber was carried out using a single slope solar still. Experiment result shows that daily yield of solar still that using iron sand as absorber affected by basin water surface level. Accumulation of daily yield V2 is on average 49% higher than V1 while V3 is 57% higher above V1 therefore it is recommended to set the water level above the surface of iron sand.

5. References

- [1] Naim M M and Abd El Kawi M A 2003 *Desalination* **153** 55-64.
- [2] El-Sebaei A A, Yaghmour S J, Al-Hazmi F S, Faidah A S, Al-Marzouki F M, and Al-Ghamdi A A 2009 *Desalination* **249** 699-706.
- [3] Deshmukh H S and Thombre S B 2017 *Desalination* **410** 91-98.
- [4] Madani A A and Zaki G M 1995 *Appl. Energy* **52** 273-281.
- [5] Murugavel K K, Sivakumar S, Ahamed J R, Chockalingam K K S K, and Srithar K 2010 *Appl. Energy* **87** 514-523.
- [6] Srivastava P K and Agrawal S K 2013 *Desalination* **311** 198-205.
- [7] Srivastava P K and Agrawal S K 2013 *Desalination* **319** 73-78.
- [8] Sellami M H, Guemari S, Touahir R, and Loudiyi K 2016 *Desalination* **394** 155-161.
- [9] Dumka P and Mishra D R 2018 *Desalination* **437** 15-25.
- [10] Elango T and Murugavel K K 2015 *Desalination* **359** 82-91.
- [11] Liu K, Li Y, Wang F, Ren J, and Xie H 2018 *Constr. Build. Mater.* **178** 144-152.
- [12] Suroso I 2017 *Teknika. STTKD: Jurnal Teknik, Elektronik, Engine* **4** 26-38.
- [13] Zurigat Y H and Abu-Arabi M K 2004 *Appl. Therm. Eng.* **24** 1061-1072.
- [14] Sellami M H, Touahir R, Guemari S, and Loudiyi K 2016 *Desalination* **398** 180-188.