

## THE PRACTICE OF E-LEARNING BASED LEARNING MANAGEMENT

**Hamid Al Jufri**

Muhammadiyah University of Prof. Dr. HAMKA, DKI Jakarta,  
INDONESIA.

**jufri@uhamka.ac.id**

### ABSTRACT

*This study aims to create a learning management model based on e-learning in the context of improving the quality of e-based learning which is now less manageable. E-learning based learning management is profoundly potential to make the learning process more effective for both students and teachers significantly in terms of place, time and cost. This research was conducted by using quantitative approach. Statistical testing of the t-test at  $\alpha = 0.05$  (95% significance level) is employed to compare learning outcomes between the experimental groups. The results showed that such e-learning based learning model helps students in learning and acquires learning outcomes significantly higher, that is ( $P > 0.95$ ) compared with students studying with conventional learning. E-learning model improves the effectiveness of lecture's performance of faculty and students' achievement due to the utilization of more efficient space, time, cost, and energy. Thereby, e-learning based learning model is effective to improve the quality of teaching and learning as a whole.*

**Keywords:** learning management, computer technology and e learning

### INTRODUCTION

The occurrence of today's changes requires every person, group, institution, organization and even the nation / state to prepare as well as possible in the face of such changes. Preparation efforts through education in developed countries have been done, including by developing courses such as Global Education, International Education, and Multi-Cultural Education, followed by the development of e-Learning. Such a thing is intended for human being to be able to follow it and if possible they might affect the change itself. The era of globalization does have a large impact on various aspects of human life, including education.

The development of technology, especially information technology in the past five decades has increasingly been sensed by the use of computer to process data and communicate more broadly. The information technology has opened a social networking system indefinitely in a variety of interests, beyond the boundaries of culture, religion, and ideology. People's appreciation to the use of computer is getting increased, particularly in education, as a means of education. Various types of software programs as a medium are highly needed to help students in learning process because education media in a broader perspective are all tools or materials which can be used in learning communication (Yusufhadi Miarso, 1989). Advances in technology in presenting information systems has grown remarkably, indicating people can access information instantaneously in various forms, and even penetrated into various fields such as education, business, work procedures, management, to the domestic

life. John Chambers, the CEO of Cisco Systems says that for the next era, applications in the world of education will be the very influential "killer application". The Commerce Department and the US education department even jointly launched the "Vision of 2020 is related to the concept of information technology-based education" (e-learning) [Vision 2002].

E-learning is a rapidly growing field and gets a lot of attention in the world of education and has opened the door to the birth of the world libraries. In addition, means of e-mail or electronic mail encourage the education community to take advantage of the communication between students and educators more effectively and efficiently. E-learning based learning system is a form of learning implementation employing technology and is not limited by space and time. It means a learning step is performed both synchronous and asynchronous way. There are four things in the use of e-learning namely: (a) Improve productivity. (b) Accelerate the process of innovation, (c) Efficiency; and (d) Flexible and interactive. (Kamarga, 2002). While Vaughan Waller (2001) says that e-learning is an effective learning process generated by combining the digital delivery of subject matters consisting of support and learning service. All of such a thing will ultimately be determined by what has been known as Management Information Systems. To achieve the knowledge society as a result of the concepts that have been known as community learning (learning society), the knowledge must be able to manage well in order to be used for the betterment of individuals, organizations, and society as a whole. E-learning technologies cannot be longer inevitable that e-learning based program is very very beneficial for faculty and students as to improve learning process.

## **RESEARCH QUESTIONS**

1. Does the planning positively relate to e-learning-based learning?
2. Does the organization have a positive relationship to e-learning?
3. Does the evaluation have a positive relationship to e-learning?
4. Does the planning positively relate to the organization?
5. Does the organization have a positive relationship to the evaluation?
6. Does the evaluation positively relate to planning?

## **RESEARCH METHOD**

This is a quantitative research approach by using survey methods and the correlation technique. The study population is graduate students of Muhammadiyah Prof. DR. Hamka University Jakarta with 27 students as a sample by employing a proportional random sampling technique. For data collection technique, questionnaire was adopted by Likert scale model with 5 options, namely Strongly Agree, Agree, Neutral, Disagree and, Strongly Disagree, with a range of scores 5, 4, 3, 2, 1. The study was designed to obtain information about the relationship between dependent variable and the independent variable as elaborated: (1). The relationship between  $X_1$  and Y; (2). The relationship between  $X_2$  and Y; (3). The relationship between  $X_3$  and Y; (4). The relationship between  $X_1$  and  $X_2$  together and Y; (5). The relationship between  $X_2$  and  $X_3$  together and Y (6). The relationship between  $X_1$ ,  $X_2$  and  $X_3$  together and Y. This study uses a constellation relationship design of independent variables and the dependent variable.

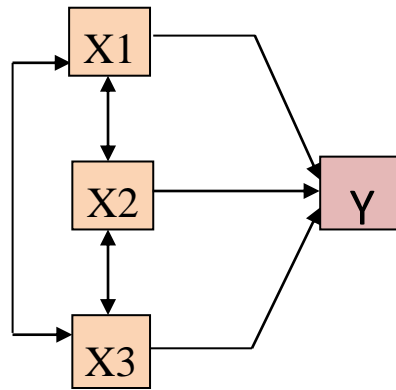

Y : *e-Learning*, X<sub>1</sub> : Planning, X<sub>2</sub> : organizing, X<sub>3</sub> : Controlling

## THEORETICAL REVIEW

### E-Learning

Thompson et al. (2000), "E-learning is instructional content or learning experiences delivered or enabled by electronic technology" Then Thompson also mentioned the advantages of e-learning that can provide flexibility, interactivity, speed, and visualization through the various advantages of each technology. According to Darin E. Hartley (2001) "E-learning is a type of learning that allows teaching material delivery for students to use Internet, Intranet or other computer network". "E-Learning is a generic term for all technologically supported learning using an array of teaching and learning tools as phone bridging, audio and videotapes, teleconferencing, satellite transmissions, and the more recognized web-based training or computer aided instruction also commonly referred to as online courses". (Soekartawi, Haryono & Librero, 2002).

In the e-learning, Keegan (1986) has determined six directives which characterize the learning points of e-learning as follows: (a) the separation of teachers and students who distinguish based e-learning education with face-to-face education; (b) there is an influence of educational organization that distinguishes it from private study; (c) the use of technical media: print, audio, video or computer to bring teachers and students and bring educational content; (d) the provision of two-way communication so that students can benefit from it and even take the initiative of dialogue; (e) allows a meeting once in a while for the purposes of teaching and socialization; (f) participation in the form of educational industrialization.

Pannen and Melati (1997:15) said that:

1. University student as an adult who is able to self-directed learning (self-Directing).
2. University student as an adult who has a very rich life experience which leads to a valuable learning resource.
3. University students as adults who are more interested in teaching and learning processes related to the settlement of problems and tasks.

Nevertheless, e-learning education system still rests on the main characteristics namely: (a) Non-linearity, the users are free to access (browse) learning objects and there is a facility to provide requirements depending on the knowledge of the user; (b) Self-managing, users can manage their own learning process by following the created structure; (c) Feedback-Interactivity, learning can be done interactively and feedback is provided in the learning process; (d) Multimedia-Learners style e-learning, the provision of multimedia facilities. Advantage of using multimedia is that students can understand more clearly and conspicuously in accordance with the type of students; (e) Just in time e-learning, providing

the user whenever necessary to resolve problems or if they simply want to improve their knowledge and skills; (f) Dynamic Updating, it has the ability to automatically update the content of the material on the most recent changes; (G) Easy Accessibility / Access Ease, just use the browser (and maybe some attached); (h) Collaborative learning, the learning tool allows mutual interaction, it means, the ability of communicating directly at the same time (synchronous) or communicate at different times (asynchronous).

The foregoing provides an overview to the implementation of e-learning based activity. Lecturers are very decisive factor and their skills to motivate students is crucial (Gibbon, 2002). Therefore, lecturers / teachers should be transparent to convey information about all aspects of learning activities so that students can learn well to achieve good learning outcomes. The information referred to herein includes (a) the allocation of time to learn the lessons and completion of tasks, (b) technological skills are required for students to facilitate learning activities, and (c) the facilities and equipment needed in learning activities (Rankin, 2002). In addition, a lecturer in e-learning also is actively required in discussions (Mc Cracken, 2002), for example: (a) by responding to any information from learners, (b) preparing and presenting treatises and various sources (reference) other, (c) providing guidance and encouragement to learners to interact with each other, (d) providing feedback on an individual and sustainable basis to all learners, (e) inspiring / encouraging students to stay active learning and following the discussion, and (f) helping learners to keep interact with each other.

As a guideline, features that are normally provided in the e-learning system are:

1. Information about the units involved in the learning process. Its goals and objectives are:
  - a. Syllabus
  - b. teaching methods
  - c. Course schedule
  - d. Task
  - e. Exam Schedule
  - f. List of reference or reading material
  - g. Profiles and contact teachers
2. Ease of access to the reference source (lecturers / teachers)
  - a. Textbooks and lecture notes
  - b. Presentation materials
  - c. FAQ (frequently asked questions)
  - d. Reference sources to work on the assignment
  - e. Beneficial websites
  - f. Articles in journals on-line
3. Communication
  - a. On-line discussion forum
  - b. Mailing list discussion
  - c. The notice board that provides information (class schedule changes, its tasks and deadlines)
4. Facilities for group work
  - a. A means for sharing files and directories in a group
  - b. A means of discussion for the task group
5. The on-line exam system and collecting feedback.

**RESEARCH FINDINGS**

Based on 27 respondents' opinions, the general overview of the rating planning (X1) can be explained as follows: Calculations, mean = 149.11 from the lowest score of 134 and the highest score of 159. It can be said that planning (X<sub>1</sub>) was in good category. (Table 1)

**Table 1. Description of planning rating Variabel (X<sub>1</sub>)**

		Statistic	Std. Error	
Planning (X <sub>1</sub> )	Rating	Mean	149,11	1,375
	95% Confidence Interval for Mean	Lower Bound	146,29	
		Upper Bound	151,94	
	5% Trimmed Mean	149,37		
	Median	150,00		
	Variance	51,026		
	Std. Deviation	7,143		
	Minimum	134		
	Maximum	159		
	Range	25		
	Interquartile Range	10		
	Skewness	-,587	,448	
	Kurtosis	-,655	,872	

Referring to the value of skewness of -0587, it means most answers of 27 respondents were above average or actually more respondents answered that the rating of planning (X<sub>1</sub>) was very good. Drawn from the following histogram, data distribution is clustered on the right Mean value or curve tilted to the left. (Histogram 1)

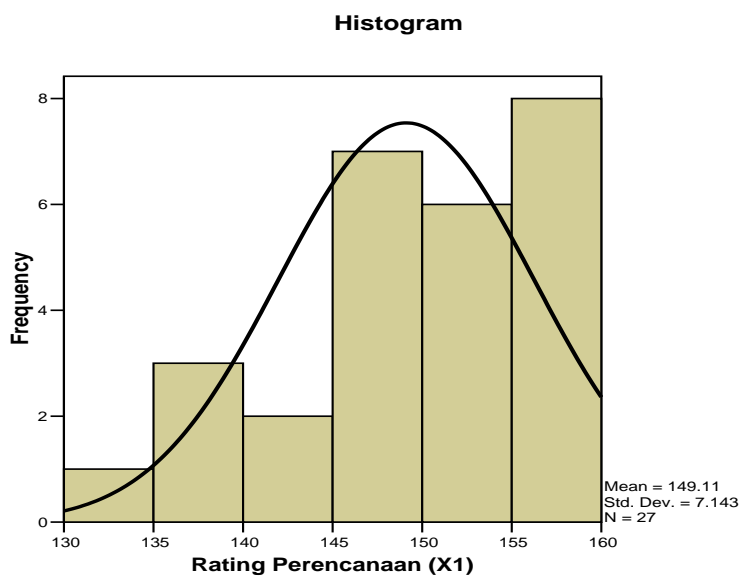

**Histogram 1. Rating of Planning (X<sub>1</sub>)**

Based on respondents' opinions, the general overview of the organizing rating (X<sub>2</sub>) can be explained as follows: Calculations, mean = 120.96 from the lowest score of 117 and the highest score of 125. It can be said organizing rating (X<sub>2</sub>) was in good category. (Table 2)

**Table 2. Description of organizing Rating (X<sub>2</sub>)**

			Statistic
Rating of organizing (X <sub>2</sub> )	Mean		120,96
	95% Confidence Interval for Mean	Lower Bound	119,97
		Upper Bound	121,96
	5% Trimmed Mean		120,97
	Median		121,00
	Variance		6,345
	Std. Deviation		2,519
	Minimum		117
	Maximum		125
	Range		8
	Interquartile Range		4
	Skewness		-,064
	Kurtosis		-1,353

Referring to the value of skewness in the table above, namely -0064 means most answers of 27 respondents were above average or actually more respondents answered that the rating of organizing (X<sub>2</sub>) was very good. Drawn from the following histogram, data distribution is clustered on the right Mean value or curve tilted to the left. (Histogram 2)

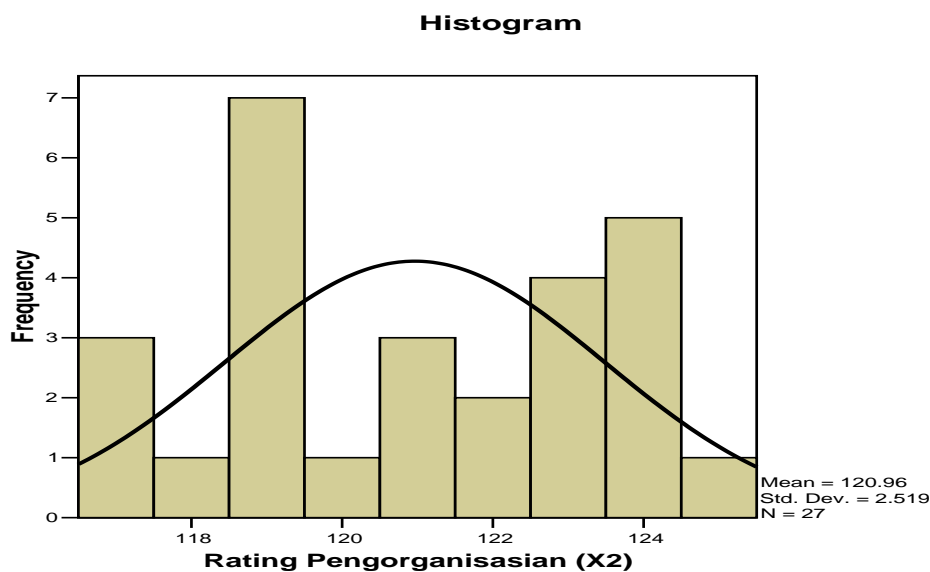

**Histogram 2. Rating of organizing (X<sub>2</sub>)**

Based on respondents' opinions, the general overview of the controlling rating (X3) can be explained as follows: Calculations, mean = 103.93 from the lowest score of 97 and highest score of 113. it can be said controlling rating (X3) was in good category. (Table 3)

**Tabel 3. Description of controlling Rating (X3)**

			Statistic
Rating of controlling (X3)	Mean		103,93
	95% Confidence Interval for Mean	Lower Bound	102,69
		Upper Bound	105,16
	5% Trimmed Mean		103,81
	Median		104,00
	Variance		9,764
	Std. Deviation		3,125
	Minimum		97
	Maximum		113
	Range		16
	Interquartile Range		3
	Skewness		,703
	Kurtosis		2,283

Referring to the value of skewness in the table above, that is 0703 means most answers of 27 respondents were below average or actually more respondents answered that the rating of organizing (X2) was pretty good. Drawn from the following histogram, data distribution is clustered on the left side of Mean value or curve tilted to the right. (Histogram 3)

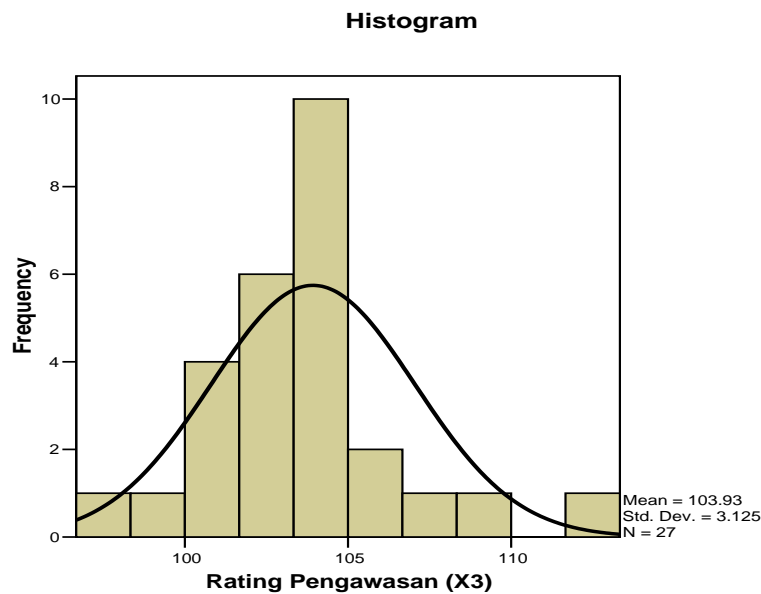

**Histogram 3. Rating of controlling (X3)**

Fourth, student results. Based on the opinion of 27 respondents that only 5 students who have a score with A category, 18 students who have a score with B category and 4 students who have a score C category. The results of this study showed the average student has been good categories in the e-learning. (Table 4.)

**Tabel 4. Students' learning results \* Crosstabulation of Grade category**

Score	Grade category			Total
	A (80 - 100)	B (69 - 79)	C (55 - 68)	
Students' learning result	65	0	0	3
	68	0	0	1
	69	0	5	5
	70	0	8	8
	75	0	4	4
	76	0	1	1
	80	3	0	3
	85	2	0	2
<b>Total</b>		<b>5</b>	<b>18</b>	<b>4</b>
				<b>27</b>

Based on respondents' opinions, the general picture of the effectiveness of e-Learning (Y) can be explained as follows: Calculations, mean = 50.56 from the lowest score of 43 and the highest score of 55, it can be said the effectiveness of e-learning was in an effective category. (Table 5)

**Table 5. Description of the effectiveness of e-learning (Y)**

			Statistic
The effectiveness of E-learning (Y)	Mean		50,56
	95% Confidence Interval for Mean	Lower Bound	49,30
		Upper Bound	51,81
	5% Trimmed Mean		50,69
	Median		51,00
	Variance		10,103
	Std. Deviation		3,178
	Minimum		43
	Maximum		55
	Range		12
	Interquartile Range		5
	Skewness		-,662
	Kurtosis		-,232



Referring to the value of skewness in the table above, namely -0662 means most answers of 27 respondents were above average or actually more respondents answered that the e-learning (Y) was very effective. Drawn from the following histogram. data distribution is clustered on the right Mean value or curve tilted to the left. (Histogram 4)

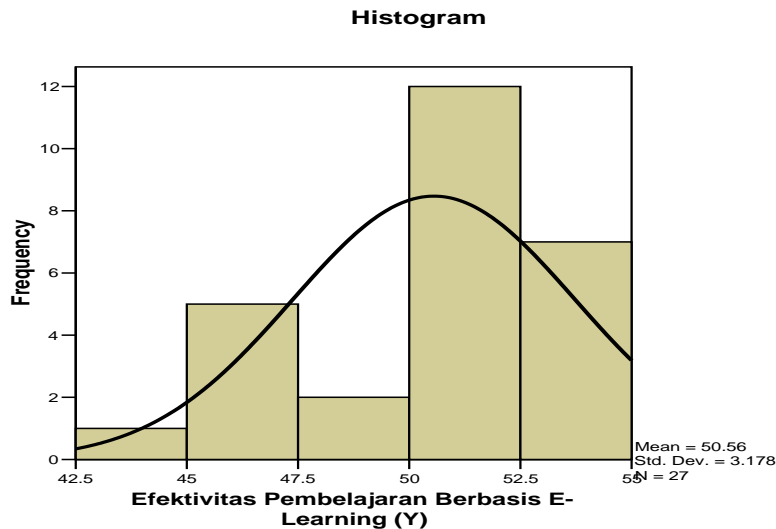

**Histogram 4. The Effectiveness of e-Learning (Y)**

**Relationship between Management and the Effectiveness of e-Learning**

To determine the relationship between management and the effectiveness of e-learning Rho Spearman of correlation test is conducted because there is one normal variable (X<sub>1</sub>) of the distribution of the research data while the X<sub>2</sub>, X<sub>3</sub> and Y are not normal. The test results of normality can be explained as follows:

To get the accuracy of the calculations, SPSS version 12.00 is used. (see Table 6)

**Table 6. Tests of Normality**

	Kolmogorov-Smirnov(a)		
	Statistic	Df	Sig.
Rating of planning (X1)	,125	27	,200(*)
Rating of organizing (X2)	,190	27	,014
Rating of controlling (X3)	,180	27	,024
The effectiveness of E-Learning (Y)	,222	27	,001

\* This is a lower bound of the true significance.

a. Lilliefors Significance Correction

The criteria of testing:

Ho: Sig <0.200 data is not normally distributed

H1: Sig = 0.200 normal distribution of data

Decision:

a. Variable X1 is in normal distribution of data for Sig. = 0.200; then Ho is rejected, H1 accepted, meaning that the data distribution of Variable X1 is Normal. In Graph 1 shows, where data is clustered around the line.

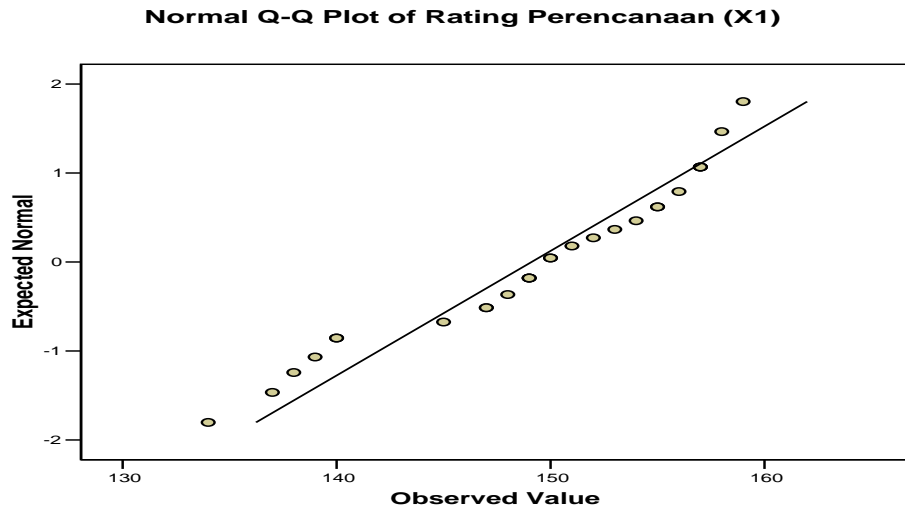

**Graphic 1. Data distribution of Variable X1**

a. X2 is in normal distribution of data for Sig. <0.200; then Ho is accepted, H1 is rejected, meaning that the data distribution of Variable X2 is not Normal. In graphic 2, data has a distance to the line.

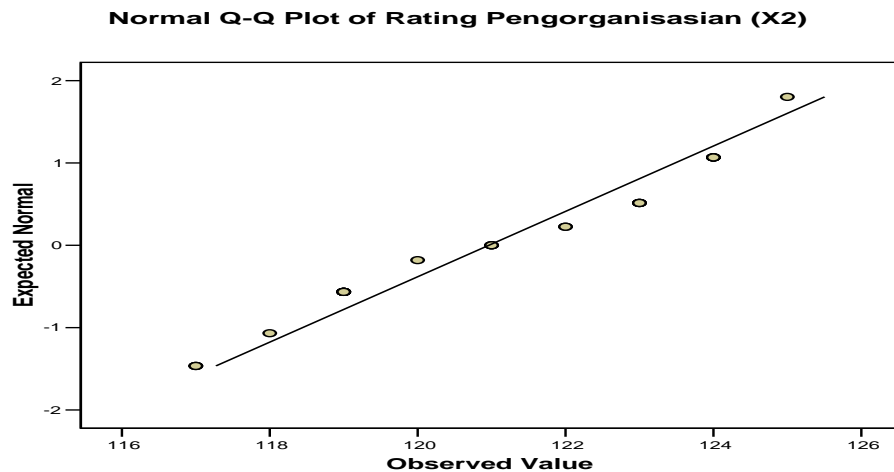

**Graphic 2. Data distribution of Variable X2**

b. X2 is in normal distribution of the data for Sig. <0.200; then Ho is accepted, H1 is rejected, meaning that the distribution data of variable X2 is not Normal. In Graphic 2 the data has a distance to the line.

Normal Q-Q Plot of Rating Pengawasan (X3)

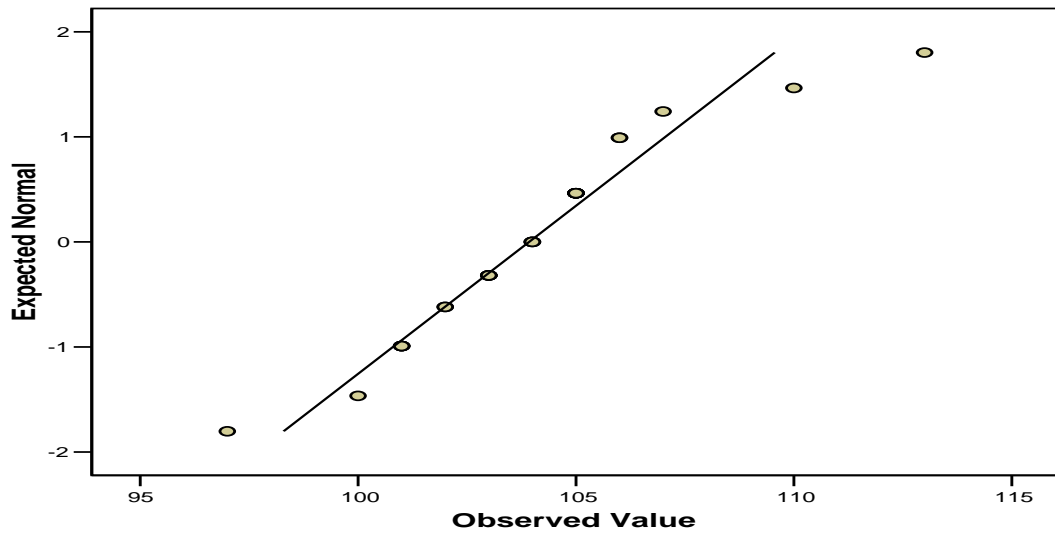

Graphic 3. Data distribution of Variable X3

- c. Variable Y is in normal distribution of data for Sig. <0.200; then  $H_0$  is accepted,  $H_1$  is rejected, meaning that the data distribution Variable Y is not Normal. Graphic 4 shows that the data has a distance to the line.

Normal Q-Q Plot of Efektivitas Pembelajaran Berbasis E-Learning (Y)

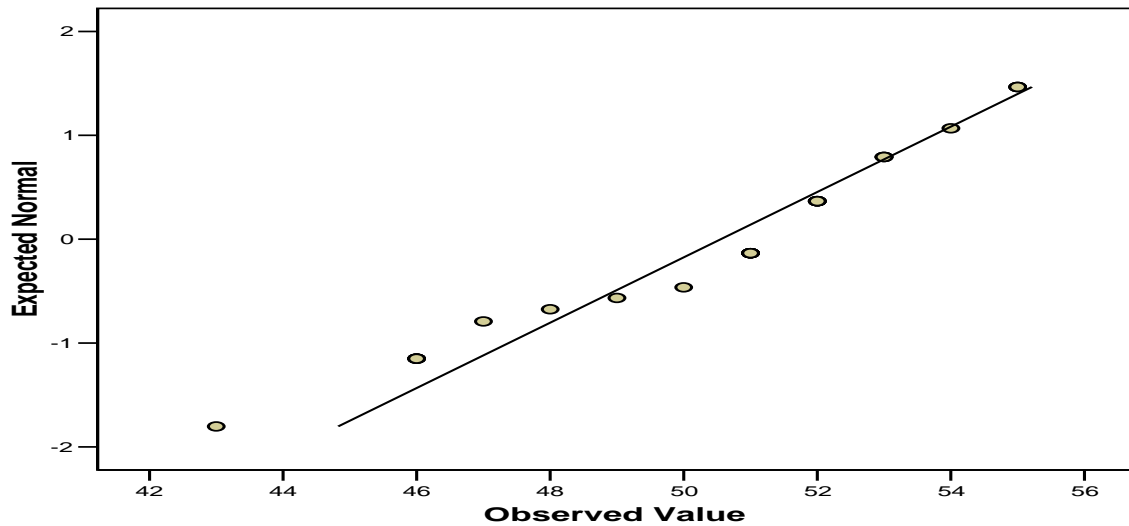

Graphic 4. Data distribution of Variable Y

Based on the test results, then it is tested by using non-parametric correlation test (Spearman Rho), the results are as follows: (Table 7)

**Table 7. The Correlation among Variables**

			Rating of planning (X1)	Rating of organizin g (X2)	Rating of controlling (X3)	The effectiveness of e-Learning (Y)
Spearman's rho	Rating of planning (X1)	Correlation Coefficient	1,000	,634(**)	,772(**)	,838(**)
		Sig. (2- tailed)	.	,000	,000	,000
		N	27	27	27	27
	Rating of organizing (X2)	Correlation Coefficient	,634(**)	1,000	,704(**)	,548(**)
		Sig. (2- tailed)	,000	.	,000	,003
		N	27	27	27	27
	Rating of controlling (X3)	Correlation Coefficient	,772(**)	,704(**)	1,000	,492(**)
		Sig. (2- tailed)	,000	,000	.	,009
		N	27	27	27	27
	Effectivens s of e- Learning (Y)	Correlation Coefficient	,838(**)	,548(**)	,492(**)	1,000
		Sig. (2- tailed)	,000	,003	,009	.
		N	27	27	27	27

\*\* Correlation is significant at the 0.01 level (2-tailed).

Based on the table above, bivariate correlation test was administered and the test results are explained as follows:

1. The correlation coefficient or  $r_{X1X2} = 0.634$ . T-test formula was used to test the hypothesis:

$$t = \frac{r\sqrt{n-2}}{\sqrt{1-r^2}} = \frac{0,634\sqrt{27-2}}{\sqrt{1-(0,634)^2}} = \frac{3,170}{0,773} = 4,099$$

The value of  $\alpha = 0.05$  to dk:  $27-2 = 25$  obtained  $t_{table} = 1,708$

The hypothesis is:

Ho : The value of  $t < t_{table}$ ; there is no significant relationship between X1 and X2

H1 : The value of  $t > t_{table}$ ; there is a significant relationship between X1 and X2

Conclusion: Due to  $4.099 > 1.708$ , then Ho is rejected and H1 is accepted or there is a positive and significant relationship with the relationship of "strong" category between X1 and X2. Classification of the relationship between variables is determined based on Table. 7.

2. The correlation coefficient or  $r_{X1X3} = 0.772$ . T-test formula was used to test the hypothesis:

$$t = \frac{r\sqrt{n-2}}{\sqrt{1-r^2}} = \frac{0,772\sqrt{27-2}}{\sqrt{1-(0,772)^2}} = \frac{3,860}{0,636} = 6,073$$

The value of  $\alpha = 0.05$  to dk:  $27-2 = 25$  obtained  $T_{table} = 1,708$

The hypothesis is:

Ho : The value of  $t < t_{table}$ ; there is no significant relationship between X1 and X3

H<sub>1</sub> : The value of  $t > t_{table}$ ; there is a significant relationship between X1 and X3

Conclusion: Because  $6,073 > 1,708$ , hence Ho is refused and H1 is accepted or there is a positive and significant relationship with "strong" category between X1 and X3. Classification of the relationship between variables is determined based on Table. 7.

3. The correlation coefficient or  $r_{X2X3} = 0.704$ . T-test formula was used to test the hypothesis:

$$t = \frac{r\sqrt{n-2}}{\sqrt{1-r^2}} = \frac{0,704\sqrt{27-2}}{\sqrt{1-(0,704)^2}} = \frac{3,520}{0,710} = 4,956$$

The value of  $\alpha = 0.05$  to dk:  $27-2 = 25$  obtained  $t_{table} = 1,708$

The hypothesis is:

Ho : the value of  $t < t_{table}$ ; there is no significant relationship between X2 and X3

H<sub>1</sub> : The value of  $t > t_{table}$ ; there is a significant relationship between X2 and X3

Conclusion: Due to  $4.956 > 1.708$ , then Ho is rejected and H1 is accepted or there is a positive and significant relationship with "strong" category between X2 and X3. Classification of the relationship between variables is determined based on Table. 7.

4. The correlation coefficient or  $r_{X1Y} = 0.883$ . T-test formula was used to test the hypothesis:

$$t = \frac{r\sqrt{n-2}}{\sqrt{1-r^2}} = \frac{0,883\sqrt{27-2}}{\sqrt{1-(0,883)^2}} = \frac{4,415}{0,469} = 9,406$$

The value of  $\alpha = 0.05$  to dk:  $27-2 = 25$  obtained table = 1,708

The hypothesis is:

Ho : the value of  $t < t_{table}$ ; there is no significant relationship between X1 and Y

H<sub>1</sub> : the value of  $t > t_{table}$ ; there is significant relationship between X1 and Y

Conclusion: Due to  $9.406 > 1.708$ , then Ho is rejected and H1 is accepted or there is a positive and significant relationship with "very strong" category between X1 and Y. Classification of the relationship between variables is determined based on Table. 7.

5. The correlation coefficient or  $r_{X2Y} = 0.548$ . T-test formula was used to test the hypothesis:

$$t = \frac{r\sqrt{n-2}}{\sqrt{1-r^2}} = \frac{0,548\sqrt{27-2}}{\sqrt{1-(0,548)^2}} = \frac{2,740}{0,836} = 3,276$$

The value of  $\alpha = 0.05$  to dk:  $27-2 = 25$  obtained  $T_{\text{table}} = 1,708$

The hypothesis is:

$H_0$  : the value of  $t < t_{\text{table}}$ ; there is no significant relationship between X2 and Y

$H_1$  : the value of  $t > t_{\text{table}}$ ; there is significant relationship between X2 and Y

Conclusion: Due to  $3.276 > 1.708$ , then  $H_0$  is rejected and  $H_1$  is accepted or there is a positive and significant relationship with the relationship of "strong enough" category between X2 and Y. Classification of the relationship between variables is determined based on Table. 7.

6. The correlation coefficient or  $r_{X3Y} = 0.492$ . T-test formula was used to test the hypothesis:

$$t = \frac{r\sqrt{n-2}}{\sqrt{1-r^2}} = \frac{0,492\sqrt{27-2}}{\sqrt{1-(0,492)^2}} = \frac{2,460}{0,871} = 2,826$$

The value of  $\alpha = 0.05$  to dk:  $27-2 = 25$  obtained table = 1,708

The hypothesis is:

$H_0$  : the value of  $t < t_{\text{table}}$ ; there is no significant relationship between X3 and Y

$H_1$  : the value of  $t > t_{\text{table}}$ ; there is significant relationship between X3 and Y

Conclusion: Due to  $2.826 > 1.708$ , then  $H_0$  is rejected and  $H_1$  accepted or there is a positive and significant relationship with the relationship of "strong enough" category between X3 and Y. Classification of the relationship between variables is determined based on Table. 7.

Based on the above calculation, it shows that X3 has the lowest correlation with the variable Y compared with other variables. It means that rating of controlling in the effectiveness of e-learning needs to be improved, especially with regard to: First, surveillance systems by using electronic payment. This occurred because the existing facilities do not optimally meet the needs in providing services to students when making a payment with an electronic system. Second, the control system of software to services payments. This is linked to the availability of software, which still needs to be developed in accordance with the demands of the students' needs. Broadly speaking, the relationship between the variables examined in this study can be found figure below:

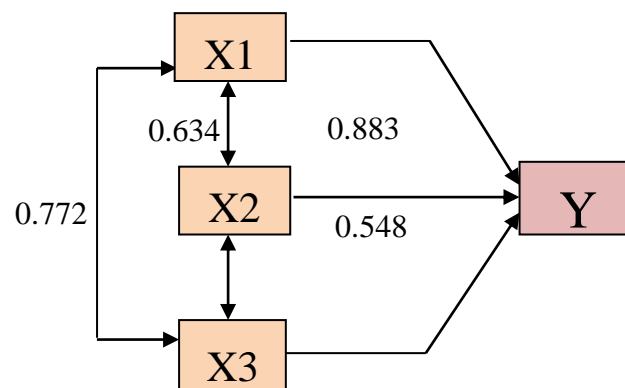

Figure 1. Relationship Constellation Between Research Variables

## CONCLUSION AND IMPLICATION

1. Situation and Condition in the practice of e-learning in Education Administration of UHAMKA conducted by lecturers have been carried out properly, ie following the procedures both in class and e-learning.
2. Model of e-learning based learning management is distinctive because for those who are not familiar with technology can use it easily. Administration and student academic bureau (BAAK) process data which make learning become integrated.
3. By using the e-learning, it can improve the ability of employees and improve the quality of teaching and learning. in addition, it can overcome individual differences of students and simultaneously improve student learning outcomes which are monitored by the academic community.
4. E-learning based learning management developed through this research is a modification of the model of Computer Based Instruction (CBI). It does not change the basic shape, but e-learning is already developed into a management model of e-learning based, with management functions comprising: a) planning, b) organizing, c) controlling. In this case the central computer and BAAK involve in e-learning.
5. Despite their concerns about the negative effects of computer use on the humanistic aspects, it can be overcome with structurely software-learning so as to create a good control.
6. Although the research findings, during the trial and the validation test of management model, show that the e-learning experienced some difficulties, this can be overcome with the cooperation of various parties. In the development stage of learning strategies, the roles of leaders and lecturers are very dominant to control student. Thus it is necessary to provide a refresher on the development of the teaching plan to the central computer, the financial administration bureau and administration and student academic bureau so that the learning process is integrated and controlled.
7. E-learning can be used together by students so as to create a conducive learning to improve teaching and learning process which can be applied to the relevant subjects.

## REFERENCES

- [1] Alhabshi, S. O. (2002). *E-learning: A Malaysian case study*. Kuala Lumpur: National Institute of Public Administration (INTAN).
- [2] Anwas, O. M. (2003). Model inovasi *e-learning* dalam meningkatkan mutu pendidikan. *Jurnal Teknodik*, 12 (VII), 28-43.
- [3] Cate, A., Thompson, M., & Hancock, B. (1999). *Handbook of distance learning*. USA: The McGraw-Hill.
- [4] Darin, E. H. (2001). *Selling e-learning*. USA: American Society for Training and Development.
- [5] Devis, B. G., & Margrethe H. (1984). *Management information systems*. USA: McGraw Hill.
- [6] George, R. T. (1977). *Principle of management*. Malaysia: Irwin Inc.

- [7] Kamarga, H. (2001). Manajemen e-learning: Mengelola pengetahuan sebagai komoditas. *Mimbar Pendidikan*, 3 (XX), 4-8.
- [8] Kamarga, H. (2002). *Belajar sejarah melalui e-learning*. Jakarta: Inti Media.
- [9] Kamarga, H. (2002). *E-learning sebagai kegiatan belajar asynchronous melalui perangkat elektronik komputer yang memperoleh bahan belajar yang sesuai dengan kebutuhannya*. Jakarta: Inti Media.
- [10] Keegan, D. (1986). *Fondation of distance education* (2<sup>nd</sup>Ed.). London: Routledge.
- [11] Keegan, D. (2002). *The use of Learning Management Systems in North Western Europe*.
- [12] Koswara, E. (2003). *Peran dunia penelitian dalam mendukung pendidikan berbasis e-learning di Indonesia*. Bandung: E-Learning Comlabs ITB.
- [13] Oetomo, B. S. D. (2002). *E-education – konsep, teknologi dan aplikasi internet pendidikan*. Yogyakarta: Penerbit ANDI.
- [14] Pannen, P. (2003). *Kualitas dalam pembelajaran*. Jakarta: Universitas Terbuka.
- [15] Pannen, P. (2004). *Teknologi pembelajaran: Peningkatan kualitas belajar melalui teknologi pembelajaran*. Jakarta: Pustekkom.
- [16] Pannen, P. (2005). *Pengembangan e-learning: Antara mitos dan kenyataan*. Jakarta: Nasional Teknologi Pembelajaran.
- [17] Russel, G. D. (1980). *Planning education for development: Volume issue and problems in the planning of education in developing countries*. Cambridge, Massachusetts: Harvard University.
- [18] Siahaan, S. (2002). Studi peninjauan tentang kemungkinan pemanfaatan internet untuk pembelajaran di SLTA di wilayah Jakarta dan sekitarnya. *Jurnal Pendidikan dan Kebudayaan*, 8 (039).
- [19] Siahaan, S. (2003). E-learning (pembelajaran elektronik) sebagai salah satu alternatif kegiatan pembelajaran. *Jurnal Pendidikan dan Kebudayaan*, 9 (042).
- [20] Siemens, G. (2004). *The e-learning framework: An online portfolio remembers more than successes – it is also a compilation of work-in-progress*. USA: Eportfolios.
- [21] Soekartawi, A. H., & Librero, F. (2002). *Prinsip dasar e-learning: Teori dan aplikasinya di Indonesia*. Indonesia: PElearning.
- [22] Soekartawi. (2002). *The role of regional organization for mass education*. Kuala Lumpur: Asian European Institute.
- [23] Soekartawi. (2003). *E-learning dan peranannya dalam pendidikan jarak jauh (e-learning and its role in distance education)*. Indonesia: Universitas Lampung, Bandar Lampung.
- [24] Thompson. (2000). *A high-resolution millennial record of the South Asian monsoon from Himalayan ice cores*. USA: The Ohio State University.