

Oktarina Heriyani - Effect of the surface of the rough pipe on the fluid flow rate

by Oktarina Heriyani Uploaded By Lutfan Zulwaqar

Submission date: 04-Apr-2023 02:45PM (UTC+0700)

Submission ID: 2055463036

File name: Heriyani_2020_IOP_Conf._Ser._Mater._Sci._Eng._909_012015_1.pdf (843.5K)

Word count: 2009

Character count: 10063

PAPER · OPEN ACCESS

Effect of the surface of the rough pipe on the fluid flow rate

To cite this article: Oktarina Heriyani *et al* 2020 *IOP Conf. Ser.: Mater. Sci. Eng.* **909** 012015

View the [article online](#) for updates and enhancements.

You may also like

- [Miniaturized rotating disc rheometer test for rapid screening of drag reducing marine coatings](#)

Simon Dennington, Ponkrit Mekkhunthod, Martin Rides *et al.*

- [Friction property evaluation of the whole surface of long fiber reinforced woven composites](#)

Jinhua Wei, Haoji Wang, Bin Lin *et al.*

- [Facile roughness fabrications and their roughness effects on electrical outputs of the triboelectric nanogenerator](#)

Saichon Sriphan and Naratip Vittayakorn



245th ECS Meeting
San Francisco, CA
May 26–30, 2024

PRiME 2024
Honolulu, Hawaii
October 6–11, 2024

Bringing together industry, researchers, and government across 50 symposia in electrochemistry and solid state science and technology

Learn more about ECS Meetings at
<http://www.electrochem.org/upcoming-meetings>

ECS Save the Dates for future ECS Meetings!

Effect of the surface of the rough pipe on the fluid flow rate

Oktarina Heriyani^{1*}, Dan Mugisidi², Irfan Hilmi²

¹Electrical Engineering, Faculty of Engineering, University of Muhammadiyah Prof. Dr. HAMKA

²Mechanical Engineering, Faculty of Engineering, University of Muhammadiyah Prof. Dr. HAMKA

*Email: oktarina@uhamka.ac.id

Abstract. The concept of controlling the flow over the circular cylinder to reduce drag force and vibration caused by vortex flow has been explored by many researchers. One of them is by adding plates and helical strakes. However, the splitter plate is only useful for determining the direction of the current, while helical strakes increase drag force compared to cylinder forces of the same diameter. The problem that arises is that the surface roughness of the pipe will affect the characteristics of the fluid flow through it, so this study aims to analyze the characteristics and effects of fluid flow through the rough surface of the outer wall of the pipe by visualizing using Particle Image Velocity (PIV). The variation of pipe roughness used in this study is the roughness of sandpaper 100 and sandpaper 400 that encloses the pipe. The results showed that the addition of surface roughness resulted in the addition of the distance of the formation of vortex where the distance of 0.07 m was the longest distance from the bottom vortex formation on the pipe wrapped in sandpaper 100.

1. Introduction

In the field of marine engineering, especially applications for offshore areas, such as the installation of platform pillars and pipelines still use a cylindrical structure. Uncontrolled flow over the fluid pipe causes the researchers to explore. Many researchers have explored the concept of controlling flow over a circular cylinder to reduce shear forces and vibrations caused by vortex flow, using several additional forms such as spiral grooves [1]. The researchers reduced drag force and vibration caused by the vortex structure by adding plate splitters [2] and helical strakes [3]. Some research results show that the addition of these tools can reduce the interaction between the two sliding layers separated from both sides of the cylinder. This results in partial or total removal of the vortex wake. However, the splitter plate is only useful for determining the direction of the current, while helical strakes increase the drag force compared to the cylinder force at the same diameter [4].

In fact the fluid flow experiences a decrease in pressure as the length of the pipe through which the fluid passes. Pressure drop is closely related to surface roughness of one of the pipes. Commercially available pipes, roughness is not uniform and not passed with certainty. The use of smooth pipe surfaces is very rarely found, whereas rough pipe surfaces are used. Likewise, the pipes are very old, usually quite a lot of crust or corrosion and dirt arise so that it has a very large roughness value. Surface roughness not only reduces the average resistance in the cylinder, but also leads to a lower critical Reynolds number [5] [6]. On the bridge pillar, vortex flow that occurs has eroded properties [7]. The problem that arises is the surface roughness of the pipe will affect the



characteristics of the fluid flow through it. This study aims to analyze the characteristics and effects of fluid flow through the rough surface of the outer wall of the pipe by visualizing using Particle Image Velocity (PIV).

2. Methodology

This research was conducted experimentally by simulating the results with Particle Image Velocity (PIV). The test is carried out using a tunnel system, like Figure 1 below:

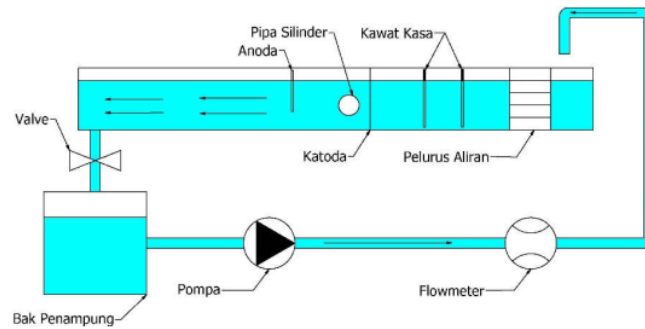

Figure 1. Testing system

In this study, the pump takes water from the reservoir and then flows into the tunnel. Water that falls into the tunnel will experience turbulence. In order to reduce the effects of turbulence, three sections of flow straighteners are provided to reduce the effect. In the part closest to the position of the fall of water, given straighteners made of straw and stream straighteners 2 and 3 made of wire mesh so that the water flowing toward the object is laminar flow. To maintain the height of the water in the tunnel, a valve is given downstream so that the outflow of water can be likened to the incoming water flow. This research was carried out at the speed of one flow by comparing two cylindrical pipes which have different surface roughness. Water flows through a flow breaker made of straws and wire mesh. Then, water flows through the cathode in the form of a 0.15 mm diameter stainless steel wire, and the anode in the form of aluminium rod, object, and returns to the reservoir. The object through which the flow passes is a pipe that has been wrapped in outer surface with sandpaper 100 and sandpaper 400. The tunnel building used has the same geometry as used in the study as figure 2 follows:

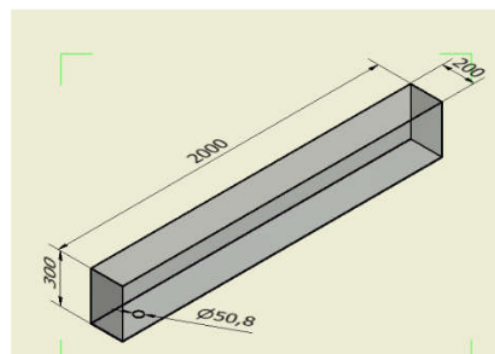

Figure 2. Tunnel geometry

Data is collected by recording phenomena that occur when bubbles are carried by flow and pass through pipes in tunnels using a 60 fps camera. Then, the video format is converted to an

image using the Video to JPG Converter software. To be simulated and analyzed, the image is reprocessed using PIVlab from MATLAB 2017.

3. Results and Discussion

Based on the results obtained that the test on the pipe wrapped in sandpaper 100 shows that a small vortex is formed on the surface of the bottom pipe, the results can be seen directly before data processing, for the process of solving the vortex can be seen in Figure 3.

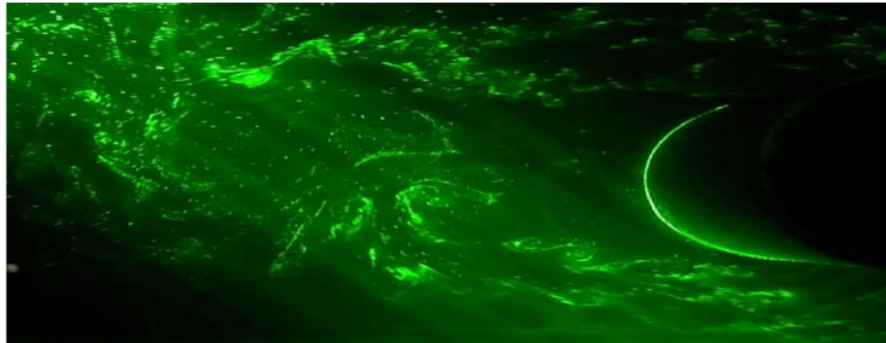

Figure 3. Vortex breaking process in pipes wrapped in 100 sandpaper

The direction of fluid movement and the recirculation zone or vortex vortex formation area can be seen in Figures 3 and 4 below.

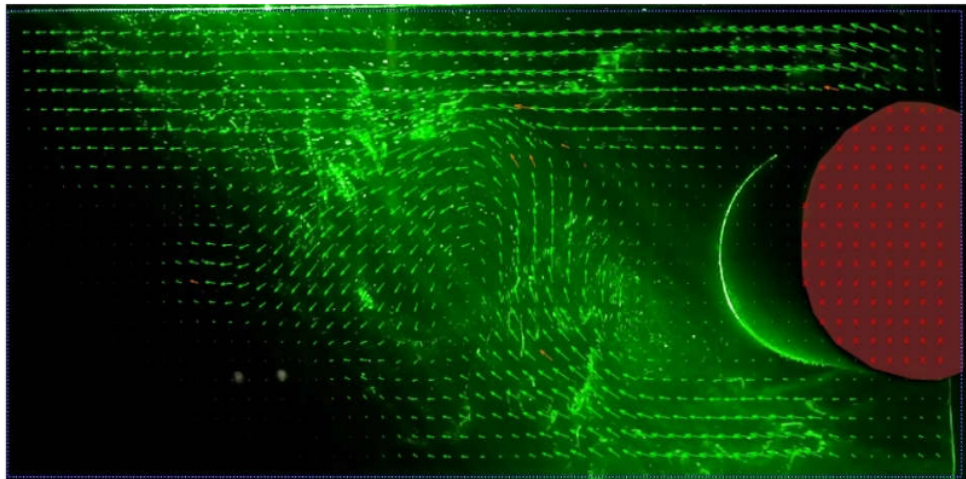

Figure 4. Vector direction on sandpaper 400

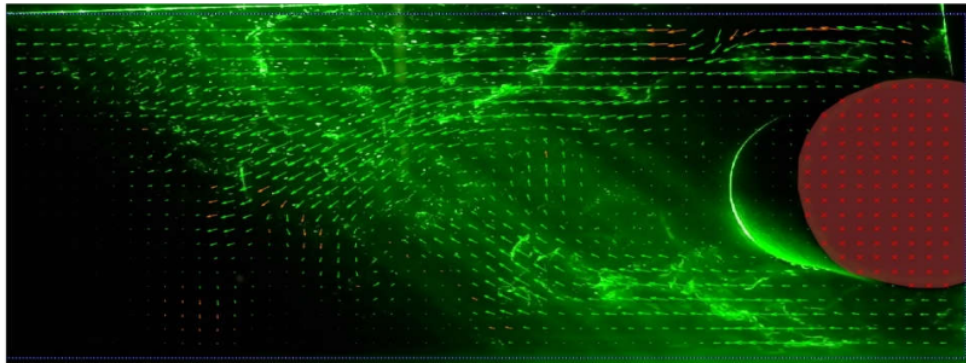

Figure 5. Vector Direction on Sandpaper 100

Figures 4 and 5 show that the direction of the vector formed has similarities in the process of vortex formation. The lower vortex is formed at a shorter distance than the upper vortex. Lower vortices are shorter because they are affected by buoyancy [8].

At the measurement of recurlation zone, sandpaper 400 produces vortex at the bottom with a distance of 0.07 m and the vortex at the top has a distance of 0.11 m from the midpoint of the cylindrical pipe, as shown in Figure 6 below.

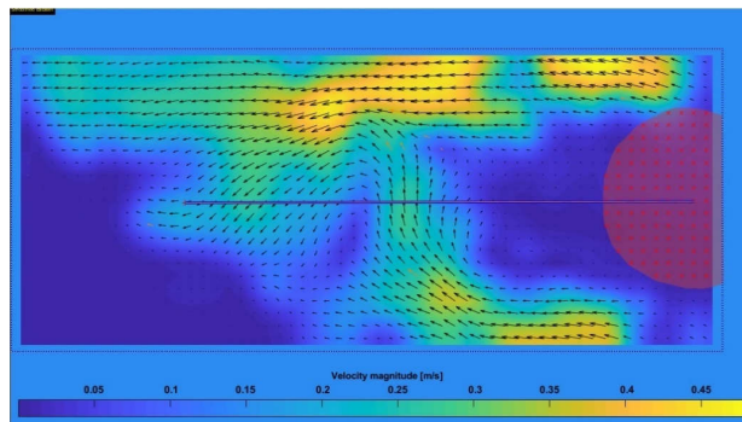

Figure 6. Velocity magnitude sandpaper 400

Measurements from the middle of the cylinder pipe to a distance of 0.16 m indicate that the highest speed profile is shown at 0.27 m/s and the lowest speed is almost 0 m/s shown in figure 7 below.

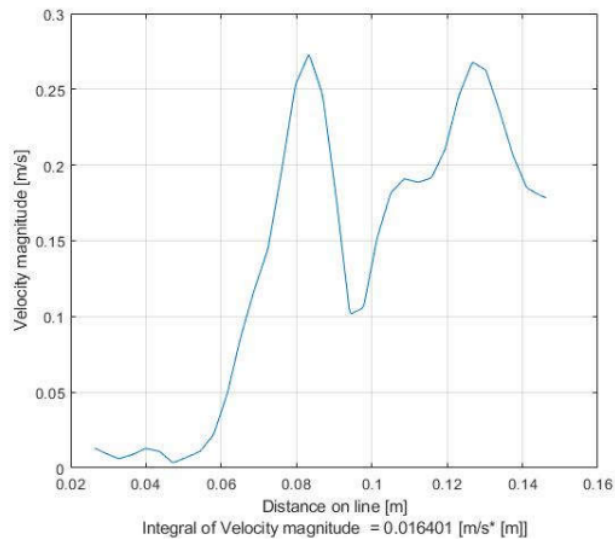

Figure 7. Sandpaper graph 400

On sandpaper 100 produces vortex on the bottom with a distance of 0.08 m and vortex on the top has a distance of 0.12 m from the midpoint of the cylinder pipe, as shown in the following figure 8.

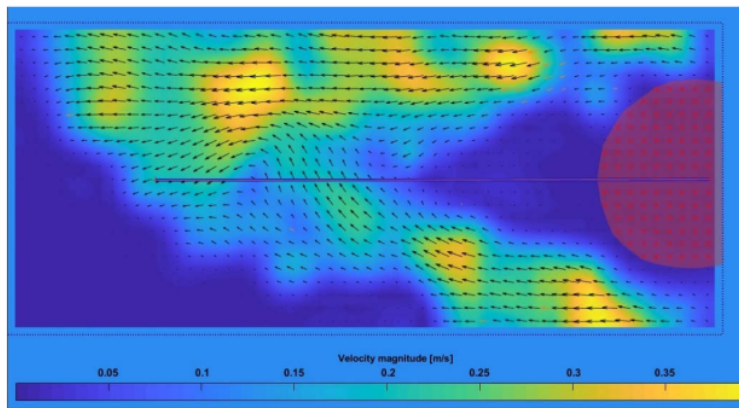

Figure 8. Velocity magnitude sandpaper 100

Measurements from the middle of the cylinder pipe to a distance of 0.16 m indicate that the highest speed profile is shown at 0.25 m / s and the lowest speed 0 m / s is shown in Figure 9.

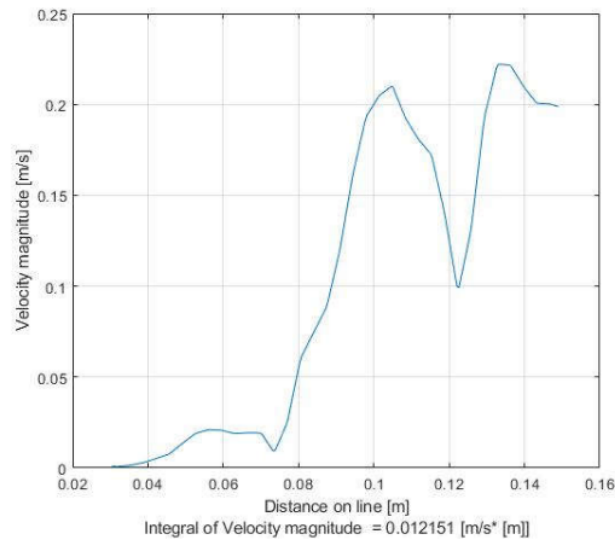

Figure 9. Sandpaper 100 graph

From the results of the analysis above shows that the vortex occurs in all the pipes at the top and bottom, the bottom vortex always forms the closest compared to the top vortex. Measurements made from the midpoint of the pipe to a distance of 0.16 m show the results of the formation of the bottom vortex closest to the pipe is a pipe wrapped in sandpaper 400 with a distance of 0.07 m, shown in figure 6. While the formation of the farthest bottom vortex, occurs in pipes wrapped in sandpaper 100 with a distance of 0.08 m, shown in Figure 8.

1 Conclusion

Fluid flow passing through the rough surface of the cylinder pipe will break the vortex flow so that at the bottom of the cylinder pipe a small vortex vortex is formed. The addition of surface roughness will result in an additional distance for the formation of vortex where the distance of 0.07 m was the longest distance from the bottom vortex formation on the pipe wrapped in sandpaper 100.

Acknowledgments

Thank you to LEMLITBANG UHAMKA for funding this internal research with contract number 667 / F.03.07 / 2019 and the UHAMKA Faculty of Engineering for facilitating its research infrastructure.

Reference

- [1] T. Zhou, S. F. M. Razali, Z. Hao, and L. Cheng 2011 On the study of vortex-induced vibration of a cylinder with helical strakes *J. Fluids Struct* **27** 903–917
- [2] H. Akilli, B. Sahin, and N. F. Tumen 2005 Suppression of vortex shedding of circular cylinder in shallow water by a splitter plate *Flow Mean Instrum* **16** 211–219
- [3] I. Korkischko and J. R. Meneghini 2010 Experimental investigation of flow-induced vibration on isolated and tandem circular cylinders fitted with strakes *J. Fluids Struct* **26** 611–625
- [4] B. Zhou, X. Wang, W. M. Gho, and S. K. Tan 2015 Force and flow characteristics of a circular cylinder with uniform surface roughness at subcritical Reynolds numbers *Appl. Ocean Res* **49** 20–26
- [5] F. K. Fuss 2011 The effect of surface skewness on the super/postcritical coefficient of drag

- of roughened cylinders *Procedia Eng* **13** 284–289
- [6] K. Y. Kiu, B. Stappenbelt, and K. P. Thiagarajan 2011 Effects of uniform surface roughness on vortex-induced vibration of towed vertical cylinders *J. Sound Vib* **330** 4753–4763
- [7] J. Ikhsan, W. Hidayat J. T. Sipil, and U. M. Yogyakarta 2006 Pengaruh bentuk pilar jembatan terhadap potensi gerusan lokal **9** 124–132
- [8] M. Bazargan D. Fraser and V. Chatoorgan 2005 Effect of buoyancy on heat transfer in supercritical water flow in a horizontal round tube *J. Heat Transfer* **127** 897–902

Oktarina Heriyani - Effect of the surface of the rough pipe on the fluid flow rate

ORIGINALITY REPORT

12%
SIMILARITY INDEX

8%
INTERNET SOURCES

4%
PUBLICATIONS

0%
STUDENT PAPERS

PRIMARY SOURCES

1 index.pkp.sfu.ca **8%**
Internet Source

2 Bo Zhou, Xikun Wang, Wie Min Gho, Soon Keat Tan. "Force and flow characteristics of a circular cylinder with uniform surface roughness at subcritical Reynolds numbers", Applied Ocean Research, 2015 **4%**
Publication

3 karyailmiah.polnes.ac.id **<1%**
Internet Source

Exclude quotes Off

Exclude matches Off

Exclude bibliography On